



Modell PW 1700 SPM

Ausführung: PW 1700 SPM (08)

Seriennummer:

Code: 12620

01/02/2010

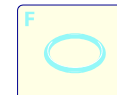
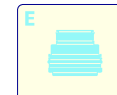
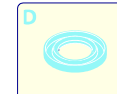
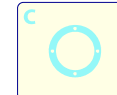
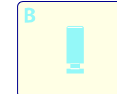
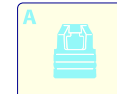
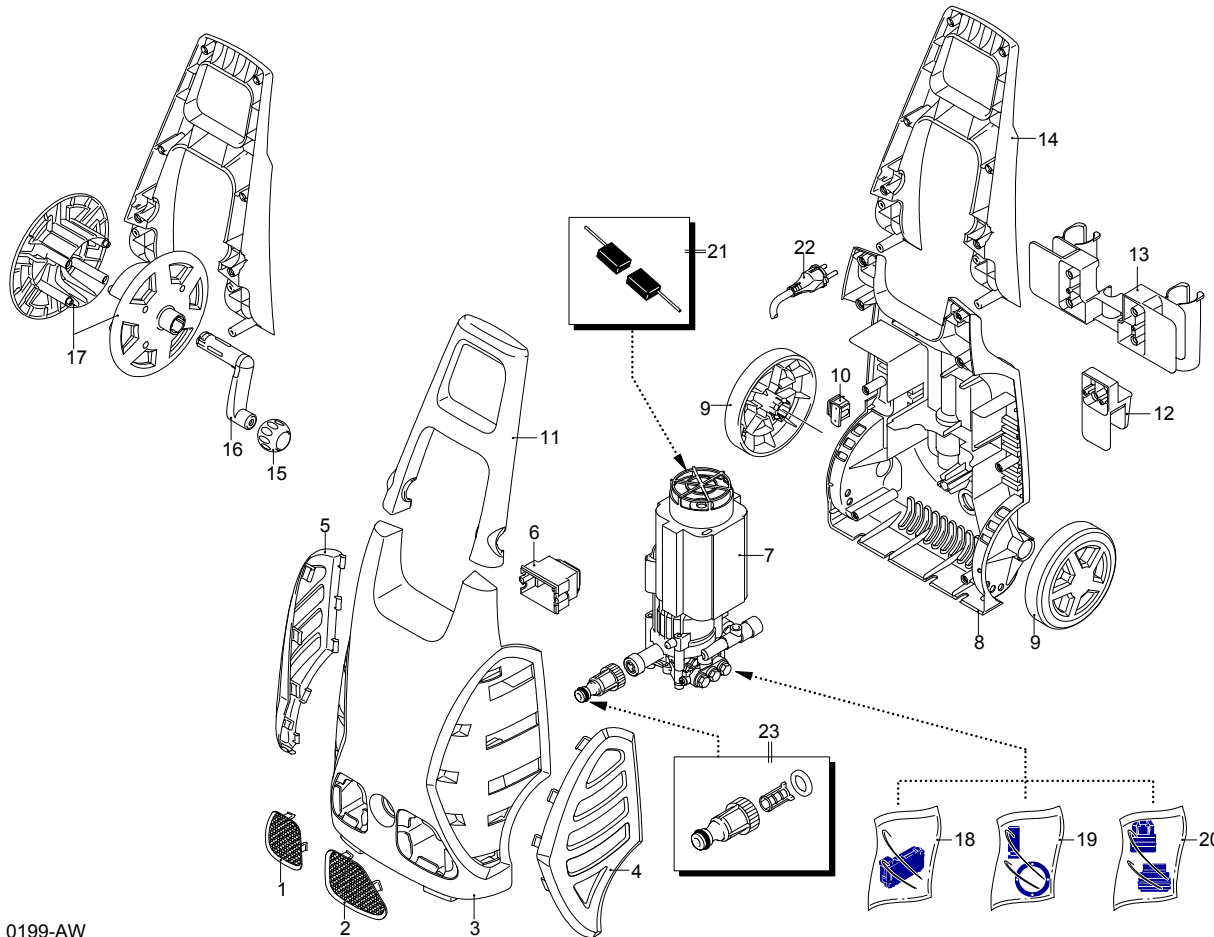
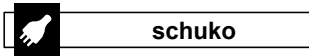
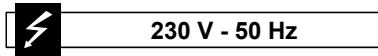

Gültigkeit	Pos.	Code	Bezeichnung	Menge
	1	3080620	Gitter	1
	2	3080630	Gitter	1
	3	3082800	Orangefarbene Haube	1
	4	3080270	Tür	1
	5	3080260	Tür	1
	6	3080170	Kasten	1
	7	3081220	Vormontage Elektropumpe	1
	8	3082910	Basis	1
	9	3080150	Rad	2
	10	3080580	Kabelverschraubung	1
	11	3080230	Griff	1
	12	3080280	Zubehörträger	1
	13	3080190	Zubehörträger	1
	14	3080210	Griff	1
	15	3080680	Knauf	1
	16	3080220	Hebel	1
	17	3080200	Scheibe	2
	18	3081280	Satz TSS	1
	19	3081270	Kolben + Dichtungssatz	1
	20	3081290	Ventile + Dichtungssatz	1
	21	3082600	Bürstesatz für Motor	1
	22	3082360	Kabel	1
	23	3082130	Wasser Schnellverbindungsatz	1

UN_CE_0199-AW



Modell PW 1700 SPM

Ausführung: PW 1700 SPM (08)

Seriennummer:

Code: 12620

01/02/2010

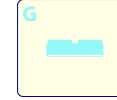
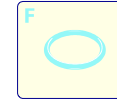
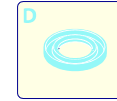
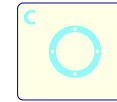
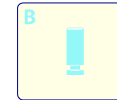
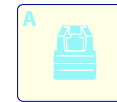
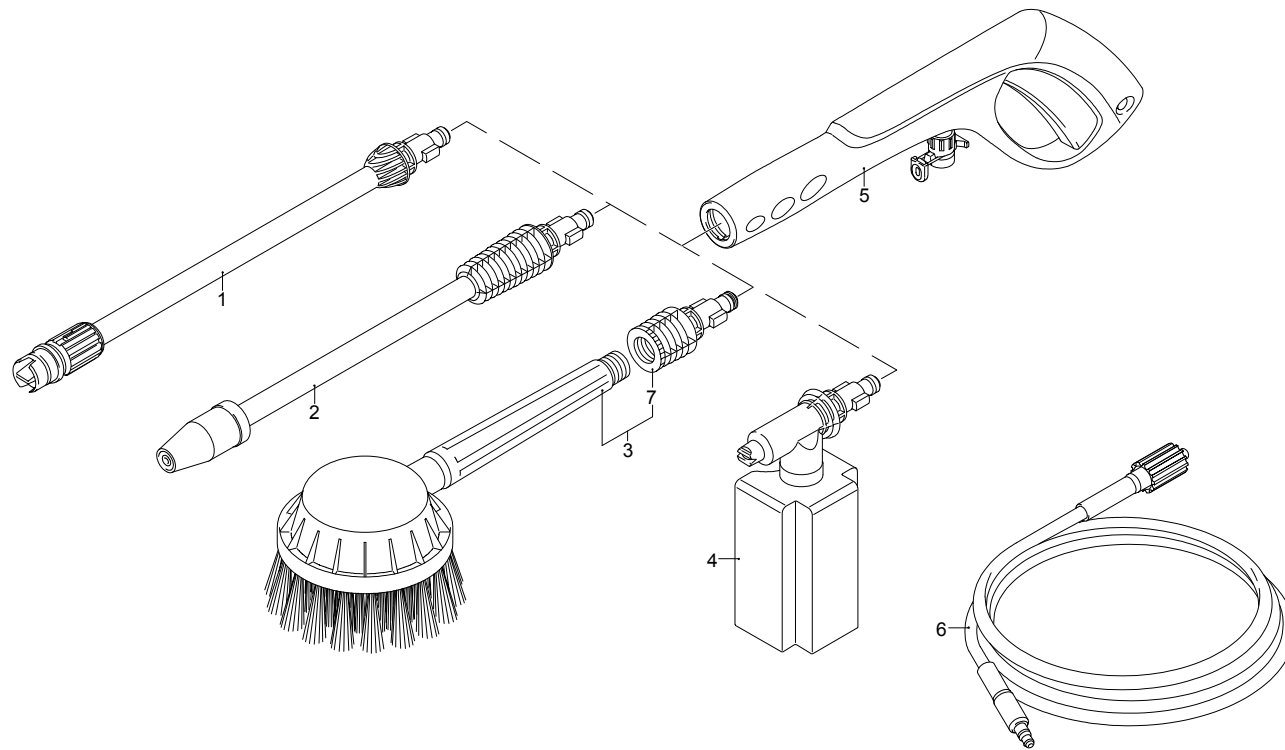
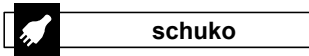
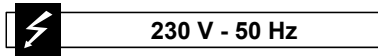

Gültigkeit	Pos.	Code	Bezeichnung	Menge
	1	50975	Lanze+Düsenkopf	1
	2	50976	Lanze+Rotopower	1
	3	3082320	Drehbürste	1
	4	50972	Tank	1
	5	50991	Pistole	1
	6	50969	Hochdruckschlauch	1
	7	40788	Adapter	1

UN_CE_0200-AW