



# Modell PW 1700 WST

Ausführung: PW 1700 WST (07)

Seriennummer:

Code: 12503

01/02/2010

230 V - 50 Hz

schuko

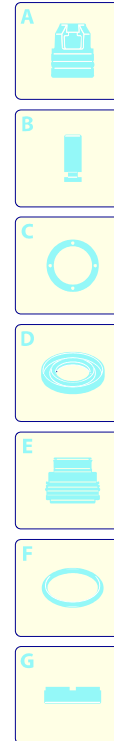
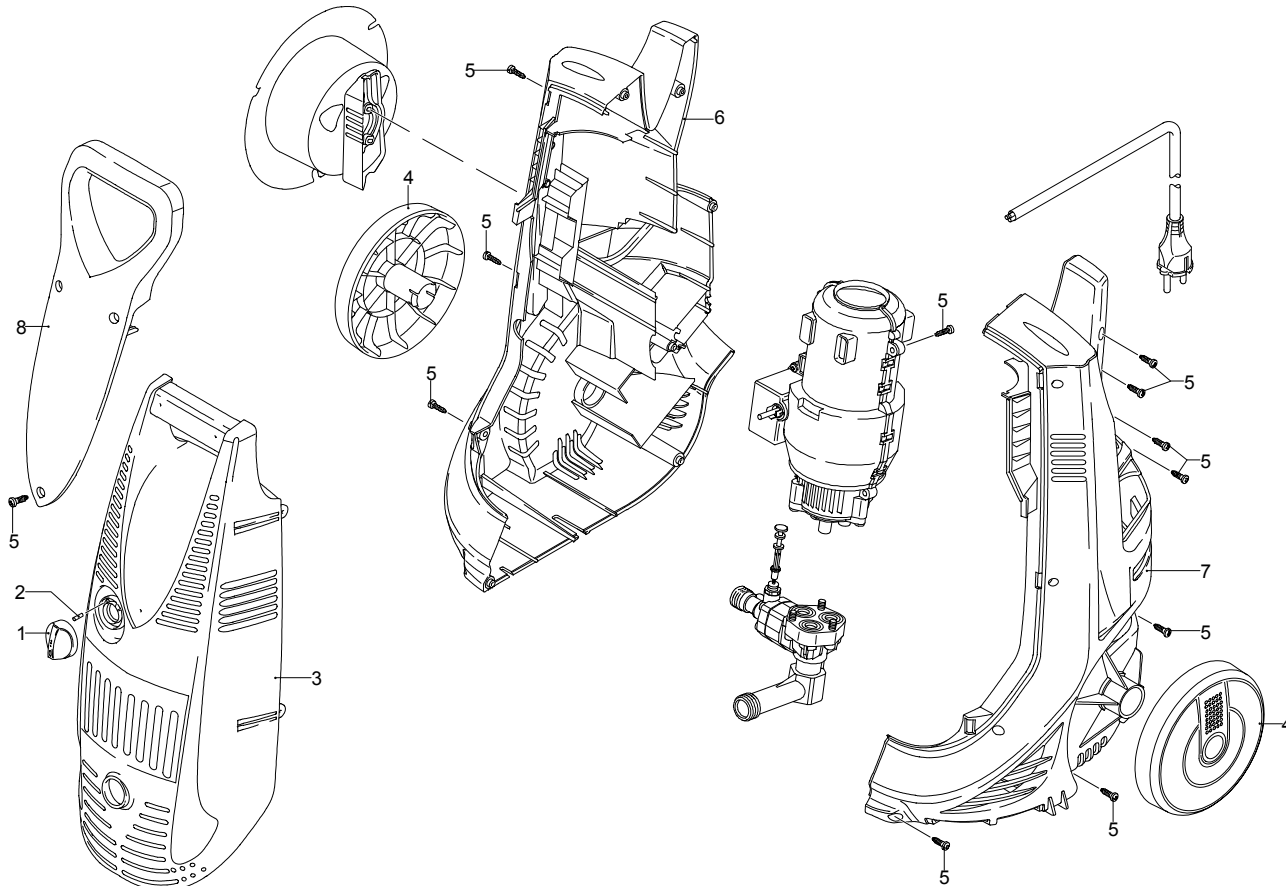

Gültigkeit	Pos.	Code	Bezeichnung	Menge
	1	2560380	Drehknopf	1
	2	2560490	Stecker	1
	3	2860200	Orangefarbene Haube	1
	4	2440071	Rad	2
	5	2100300	Schraube	19
	6	2860170	Schwarze Haube	1
	7	2860160	Schwarze Haube	1
	8	2860210	Griff	1

UN\_CE\_0159-EX



01/02/2010

# Modell PW 1700 WST

Ausführung: **PW 1700 WST (07)**

Seriennummer:

Code: **12503**

**230 V - 50 Hz**

**schuko**

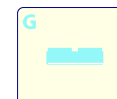
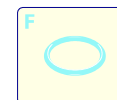
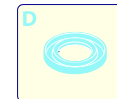
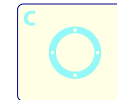
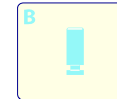
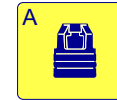
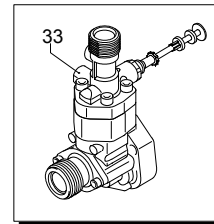
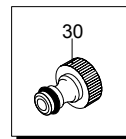
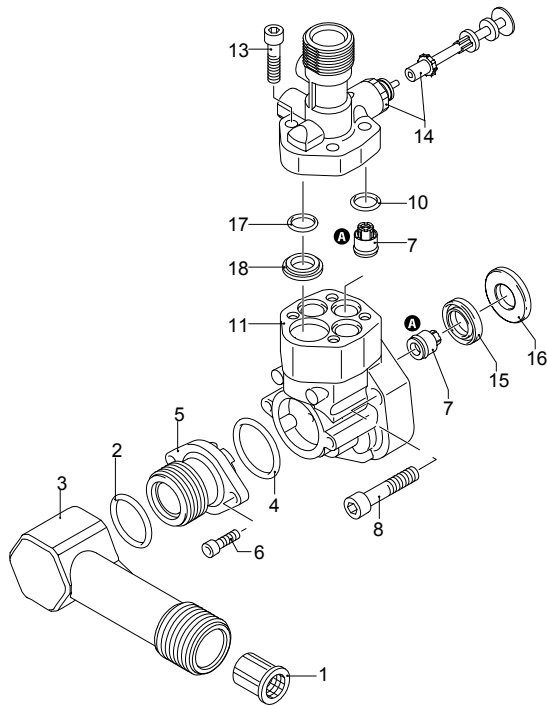

Gültigkeit	Pos.	Code	Bezeichnung	Menge
	1	1340260	Filter	1
	2	2440230	Dichtung	1
	3	2560700	Verbindungsstück	1
	4	550350	O-Ring-Dichtung	1
	5	2100540	Verbindungsstück	1
	6	2101000	Schraube	2
	7	2109050	Ventil	6
	8	850850	Schraube	3
	10	880840	O-Ring-Dichtung	4
	11	2100550	Kopf	1
	13	1260760	Schraube	4
	14	42012	Vormontage Verbindungsstück	1
	15	2200141	Wasserdichtung	3
	16	2020041	Ring	3
	17	394280	O-Ring-Dichtung	1
	18	2560480	Buchse	1
	30	1461470	Verbindungsstück	1
	33	2208	Vormontage Kopf	1
	A	2574	Satz Ventile	1

UN\_CE\_0144-AW



# Modell PW 1700 WST

Ausführung: PW 1700 WST (07)

Seriennummer:

Code: 12503

01/02/2010

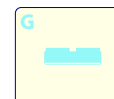
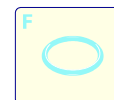
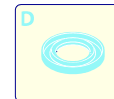
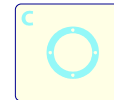
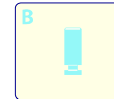
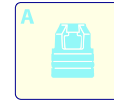
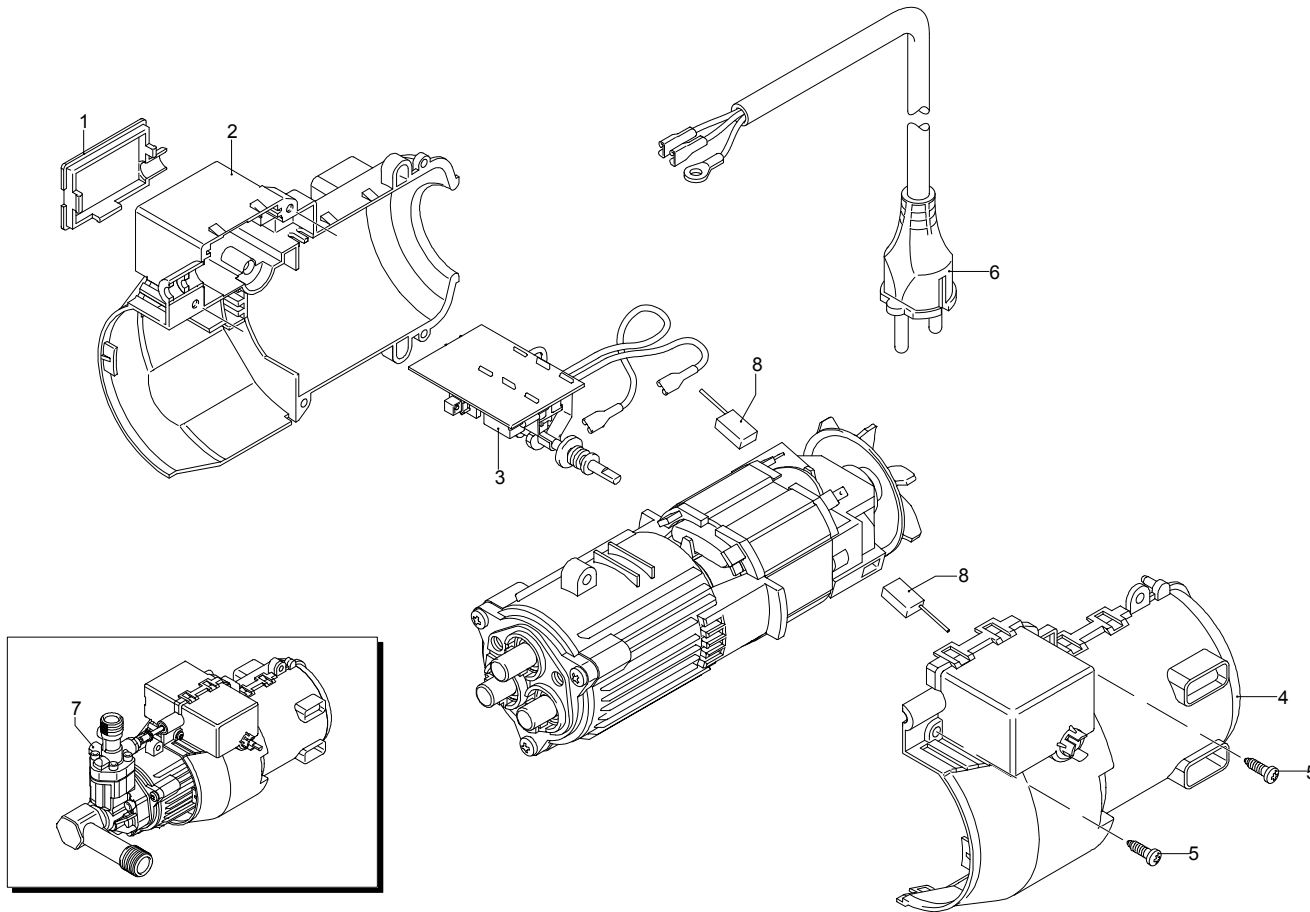
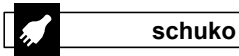
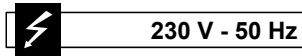

Gültigkeit	Pos.	Code	Bezeichnung	Menge
	1	2560350	Deckel	1
	2	2560130	Leitblech	1
	3	2560390	Schalter	1
	4	2560120	Leitblech	1
	5	2100300	Schraube	2
	6	2560900	Kabel	1
	7	2569618	Vormontage Elektropumpe	1
	8	2260	Bürstesatz für Motor	1

UN\_CE\_0142-KX



# Modell PW 1700 WST

Ausführung: PW 1700 WST (07)

Seriennummer:

Code: 12503

01/02/2010

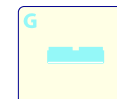
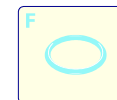
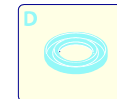
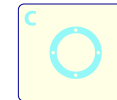
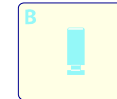
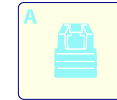
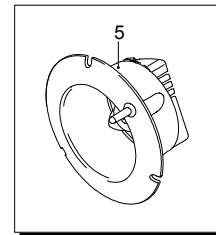
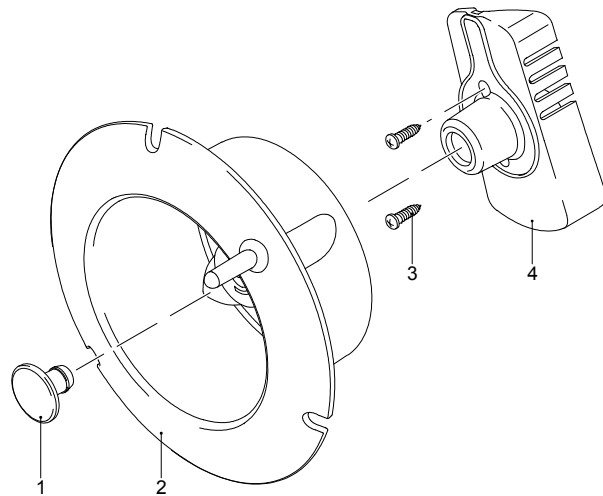
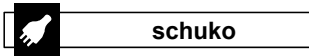
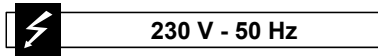

Gültigkeit	Pos.	Code	Bezeichnung	Menge
	1	2860230	Verschluss	1
	2	2860110	Schlauchhaspel	1
	3	2100300	Schraube	2
	4	2860070	Bügel	1
	5	42197	Vormontage Schlauchhaspel	1



# Modell PW 1700 WST

Ausführung: PW 1700 WST (07)

Seriennummer:

Code: 12503

01/02/2010

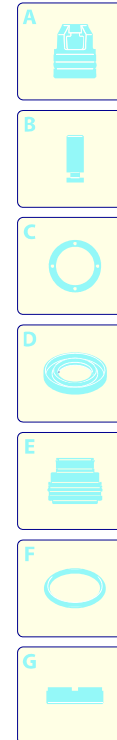
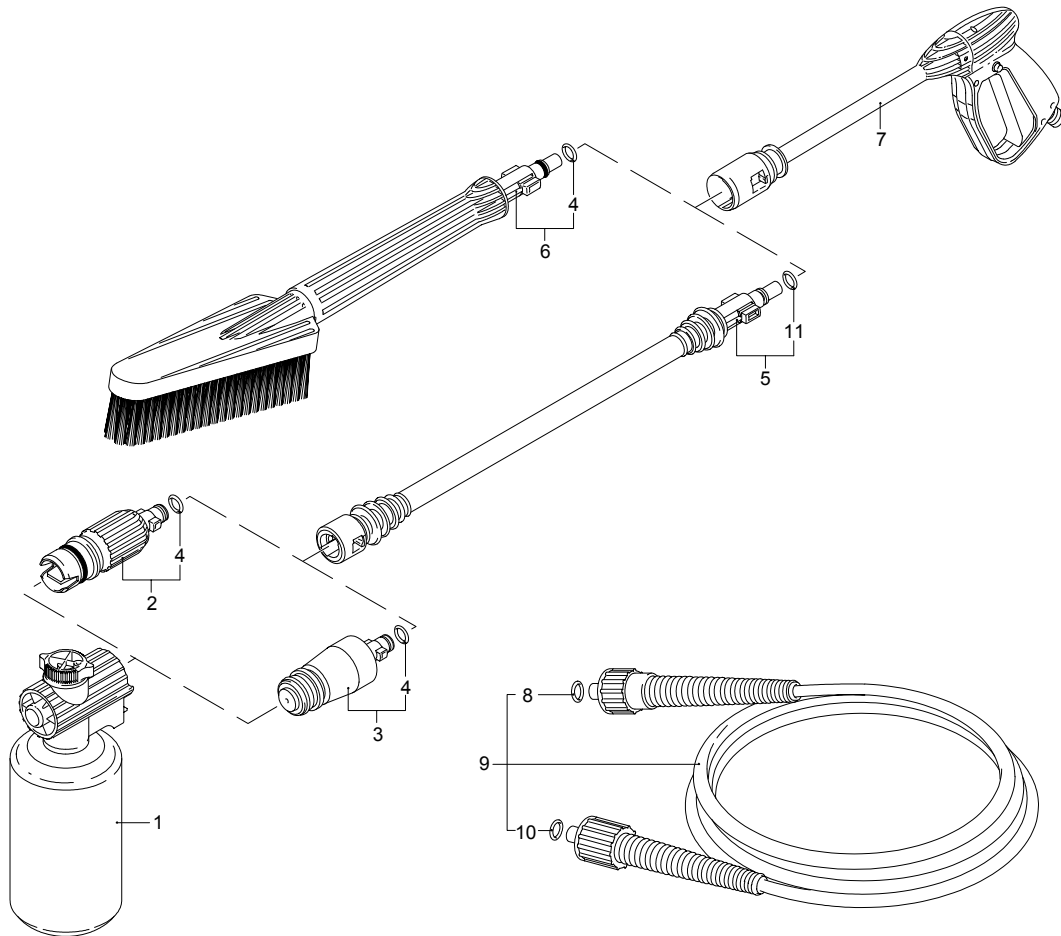
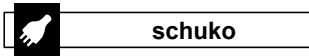
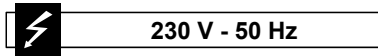

Gültigkeit	Pos.	Code	Bezeichnung	Menge
	1	40530	Tank	1
	2	40668	Düsenkopf	1
	3	40343	Düsenkopf Rotopower	1
	4	1680220	O-Ring-Dichtung	3
	5	40667	Lanze	1
	6	40417	Fixe Bürste	1
	7	40666	Pistole	1
	8	600180	O-Ring-Dichtung	1
	9	2620400	Hochdruckschlauch	1
	10	2000770	O-Ring-Dichtung	1
	11	880840	O-Ring-Dichtung	1

UN\_CE\_0145-AW