

# Modelle 737 RLW

Seriennummer:

Code:



Elektrischeanschluss:

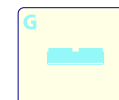
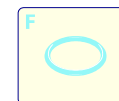
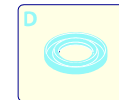
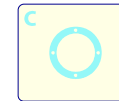
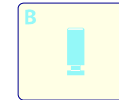
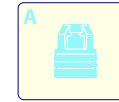
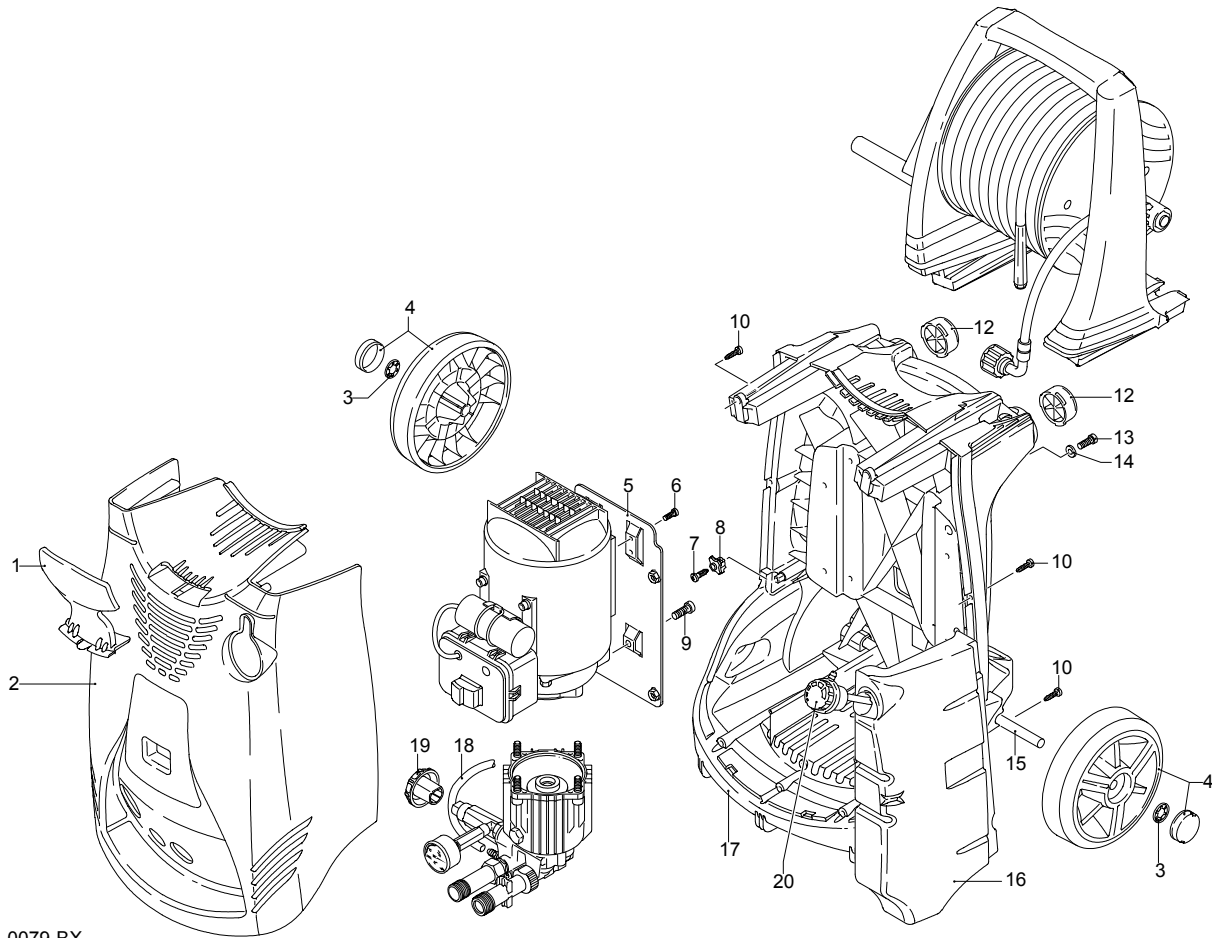

UN\_CE\_0079-BX

Pos.	Code	Bezeichnung	Menge
1	2500050	Haken	1
2	2500035	Dunkelblaue Haube	1
3	1680880	Unterlegscheibe	2
4	2500320	Rad	2
5	2500090	Platte	1
6	2320190	Schraube	2
7	2100300	Schraube	1
8	2600100	Kabelverschraubung	1
9	850370	Schraube	2
10	2100300	Schraube	7
12	2500130	Gummifuß	2
13	880280	Schraube	4
14	2180300	Unterlegscheibe	4
15	2500120	Achse	1
16	2509001	Vormontage Tank	1
17	2500010	Basis	1
18	1270960	Reinigungsmittelschlauch	1
19	2500310	Knauf	1
20	42113	Vormontage Verschluss	1

# Modelle 737 RLW

Seriennummer:

Code:



Elektrischeanschluss:

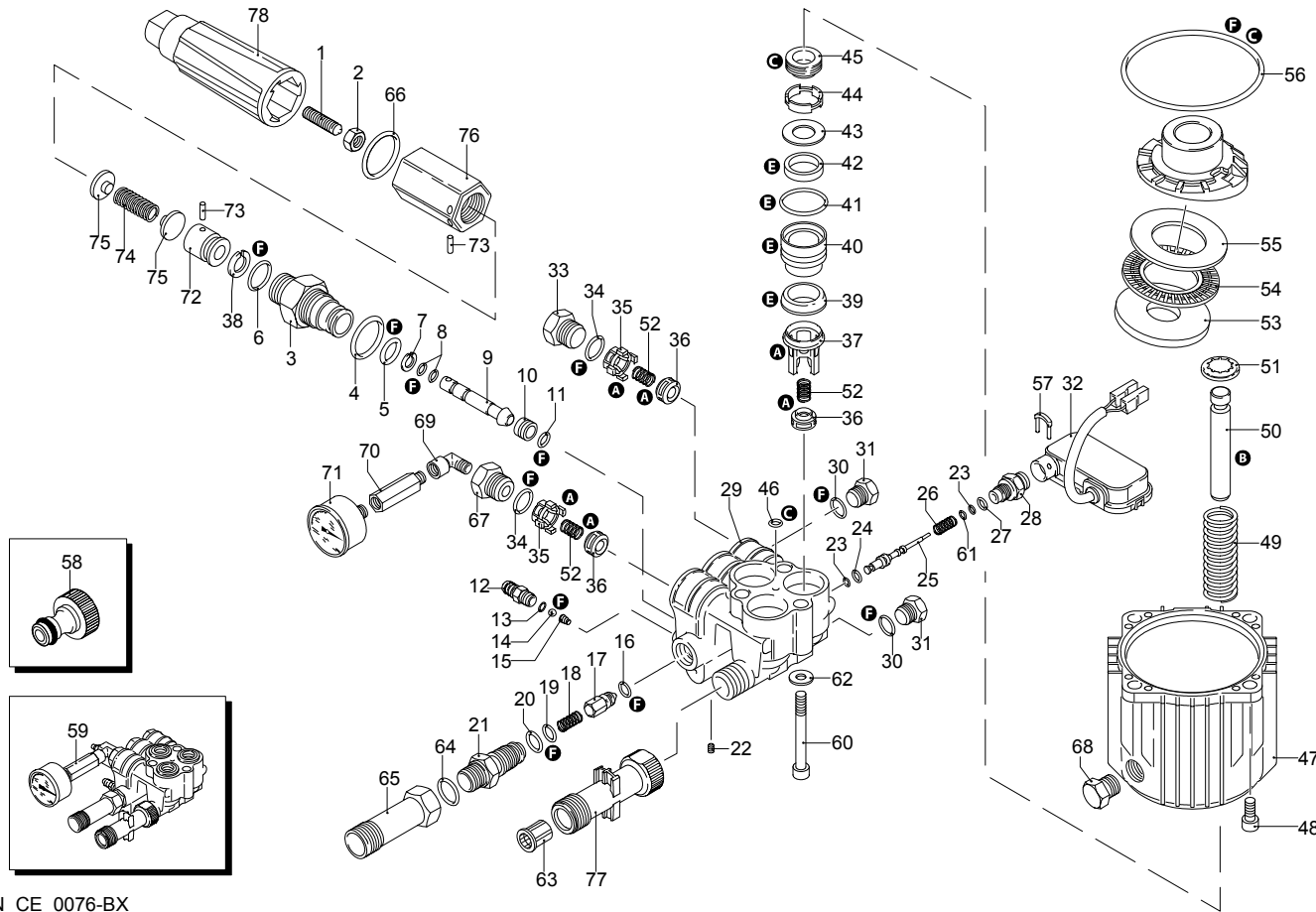

UN\_CE\_0076-BX

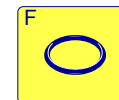
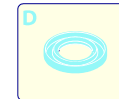
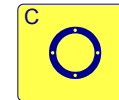
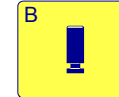
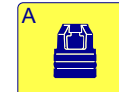

Pos.	Code	Bezeichnung	Menge
1	1980470	Schraube	1
2	1980300	Mutter	1
3	1980210	Kolbenführung	1
4	740290	O-Ring-Dichtung	1
5	800560	O-Ring-Dichtung	1
6	1080250	O-Ring-Dichtung	1
7	1271170	Ring	1
8	1080190	O-Ring-Dichtung	2
9	1271160	Kolben	1
10	1980200	Sitz	1
11	1470210	O-Ring-Dichtung	1
12	1982520	Schlauchanschluss	1
13	480480	O-Ring-Dichtung	1
14	1250280	Kugel	1
15	1560520	Feder	1
16	1460430	O-Ring-Dichtung	1
17	1540170	Verschluss	1
18	1080091	Feder	1
19	394280	O-Ring-Dichtung	1
20	1200690	O-Ring-Dichtung	1
21	1270091	Injektor	1
22	1981190	Schraube	1
23	1080190	O-Ring-Dichtung	2
24	660190	O-Ring-Dichtung	1
25	1982990	Stange	1
26	1981320	Feder	1
27	880840	O-Ring-Dichtung	1
28	1983360	Verbindungsstück	1
29	1982170	Kopf	1
30	820510	O-Ring-Dichtung	2
31	880581	Verschluss	2
32	2029752	Vormontage Kasten TSS	1
33	1260162	Verschluss	2
34	960160	O-Ring-Dichtung	3
35	1981460	Buchse	3
36	880240	Ventil	6
37	1981450	Buchse	3
38	1080401	Ring	1
39	2460180	Wasserdichtung	3
40	1981470	Kolbenführung	3
41	770130	O-Ring-Dichtung	3
42	1260440	Wasserdichtung	3
43	1980170	Ring	3
44	1980430	Distanzstück	3
45	1260460	Öldichtung	3
46	770090	O-Ring-Dichtung	1
47	1980460	Pumpenkörper	1
48	180030	Schraube	4
49	1981140	Feder	3
50	1981440	Kolben	3
51	1980150	Ring	3
52	1322230	Feder	6
53	1980130	Zapfenlager	1
54	1980250	Zapfenlager	1
55	1980240	Zapfenlager	1
56	1980340	O-Ring-Dichtung	1
57	2022200	Klemme	1
58	1461470	Verbindungsstück	1
59	1989265	Vormontage Kopf	1
60	1980310	Schraube	3
61	1260820	O-Ring-Dichtung	1
62	650530	Unterlegscheibe	3

# Modelle 737 RLW

Seriennummer:

Code:



Elektrischeanschluss:

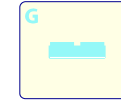
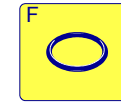
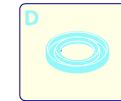
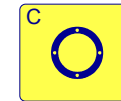
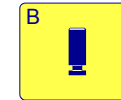
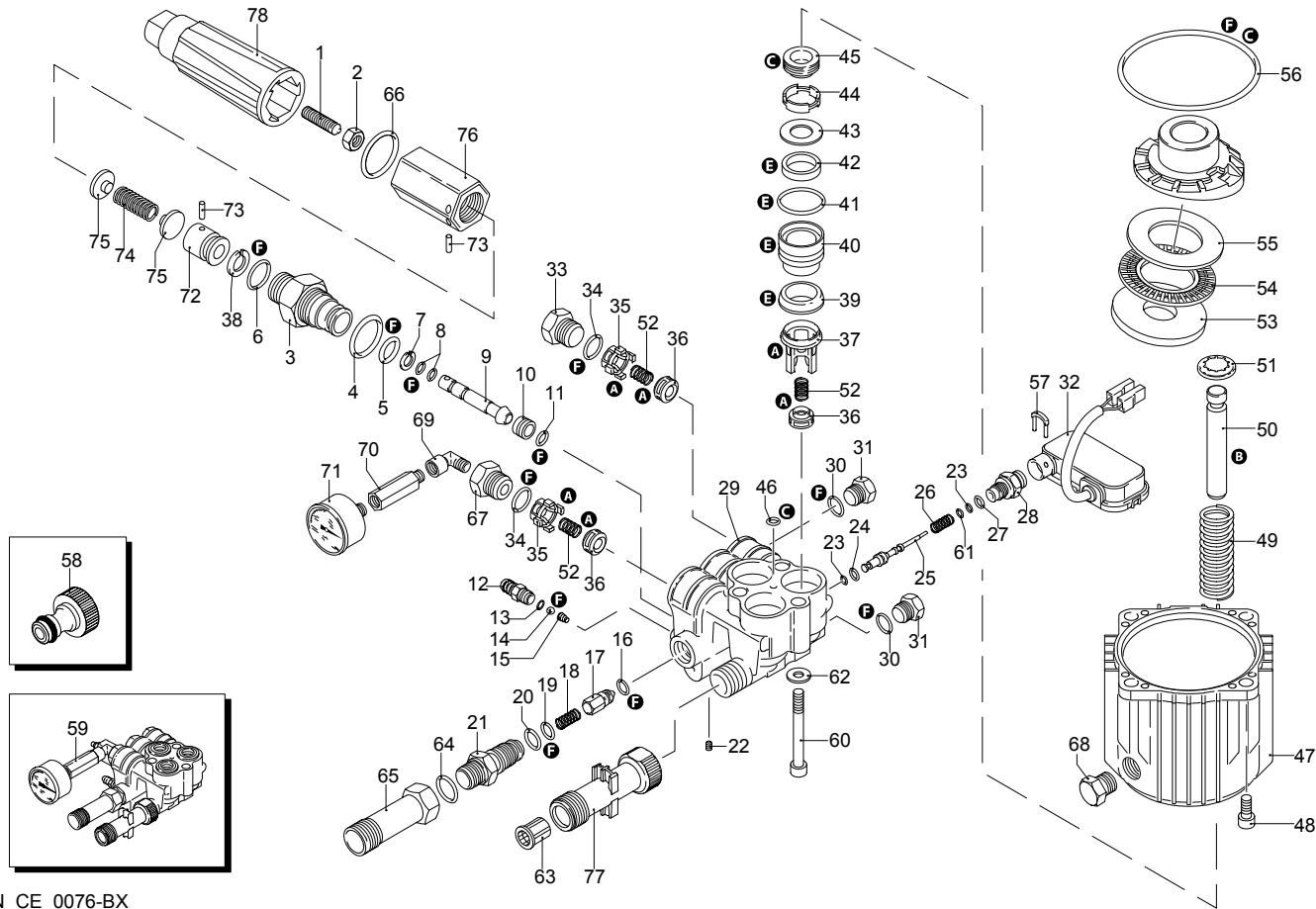

Pos.	Code	Bezeichnung	Menge
63	1340260	Filter	1
64	390180	O-Ring-Dichtung	1
65	2440210	Verlängerung	1
66	1150640	O-Ring-Dichtung	1
67	2500450	Verschluss	1
68	1980290	Verschluss	1
69	1465850	Verbindungsstück	1
70	2500140	Verlängerung	1
71	3233	Manometer	1
72	1080041	Kolben	1
73	1080070	Stecker	1
74	1271070	Feder	1
75	1980220	Teller	2
76	1980390	Einsatz	1
77	2500270	Verlängerung	1
78	2500080	Drehknopf	1
A	2581	Satz Ventile	1
B	2593	Satz Kolben	1
C	2511	Satz Öldichtungen	1
E	2582	Satz Wasserdichtungen	1
F	2799	Satz Dichtungen	1

UN\_CE\_0076-BX

# Modelle 737 RLW

Seriennummer:

Code:



Elektrischeanschluss:

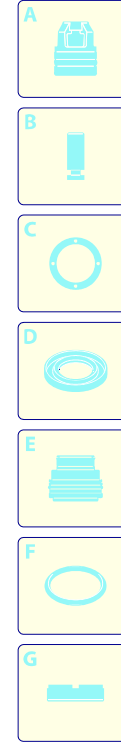
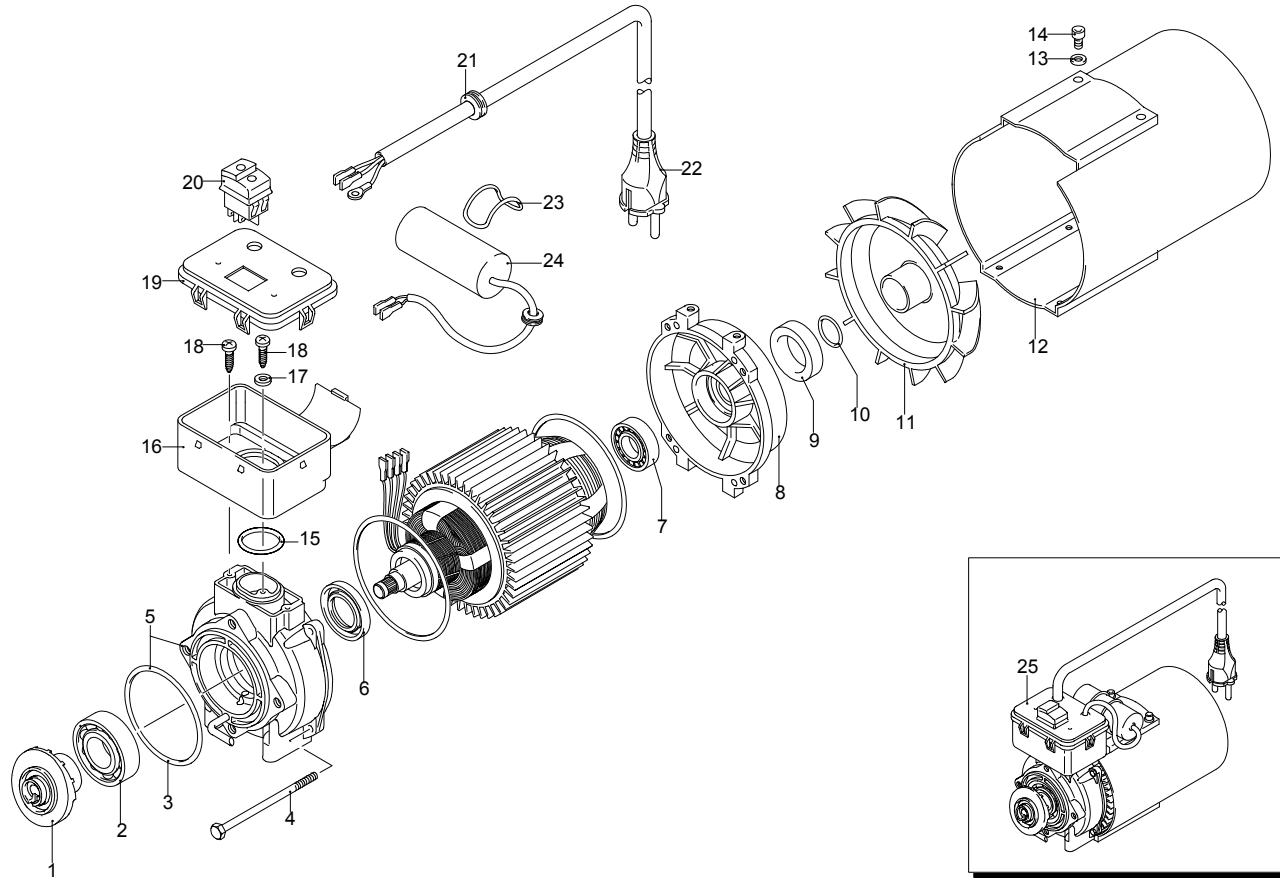

Pos.	Code	Bezeichnung	Menge
1	1983110	Teller	1
2	1981210	Lager	1
3	1980340	O-Ring-Dichtung	1
4	2320090	Schraube	4
5	1982040	Flansch	1
6	1260750	Öldichtung	1
7	1460590	Lager	1
8	1460040	Schutzschild	1
9	1461200	Öldichtung	1
10	394280	O-Ring-Dichtung	1
11	1460370	Lüfter	1
12	1460340	Leitblech	1
13	1680960	Unterlegscheibe	2
14	1460460	Schraube	2
15	660170	O-Ring-Dichtung	1
16	2320131	Kasten	1
17	1262400	Unterlegscheibe	1
18	2020570	Schraube	3
19	2320270	Deckel	1
20	2320280	Schalter	1
21	2021480	Kabeldurchführung	1
22	1760450	Kabel	1
23	2100840	O-Ring-Dichtung	1
24	1982590	Kondensator	1
25	4601	Motor	1

UN\_CE\_0077-BX

# Modelle 737 RLW

Seriennummer:

Code:



Elektrischeanschluss:

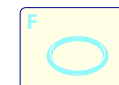
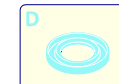
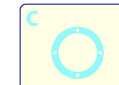
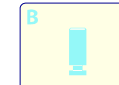
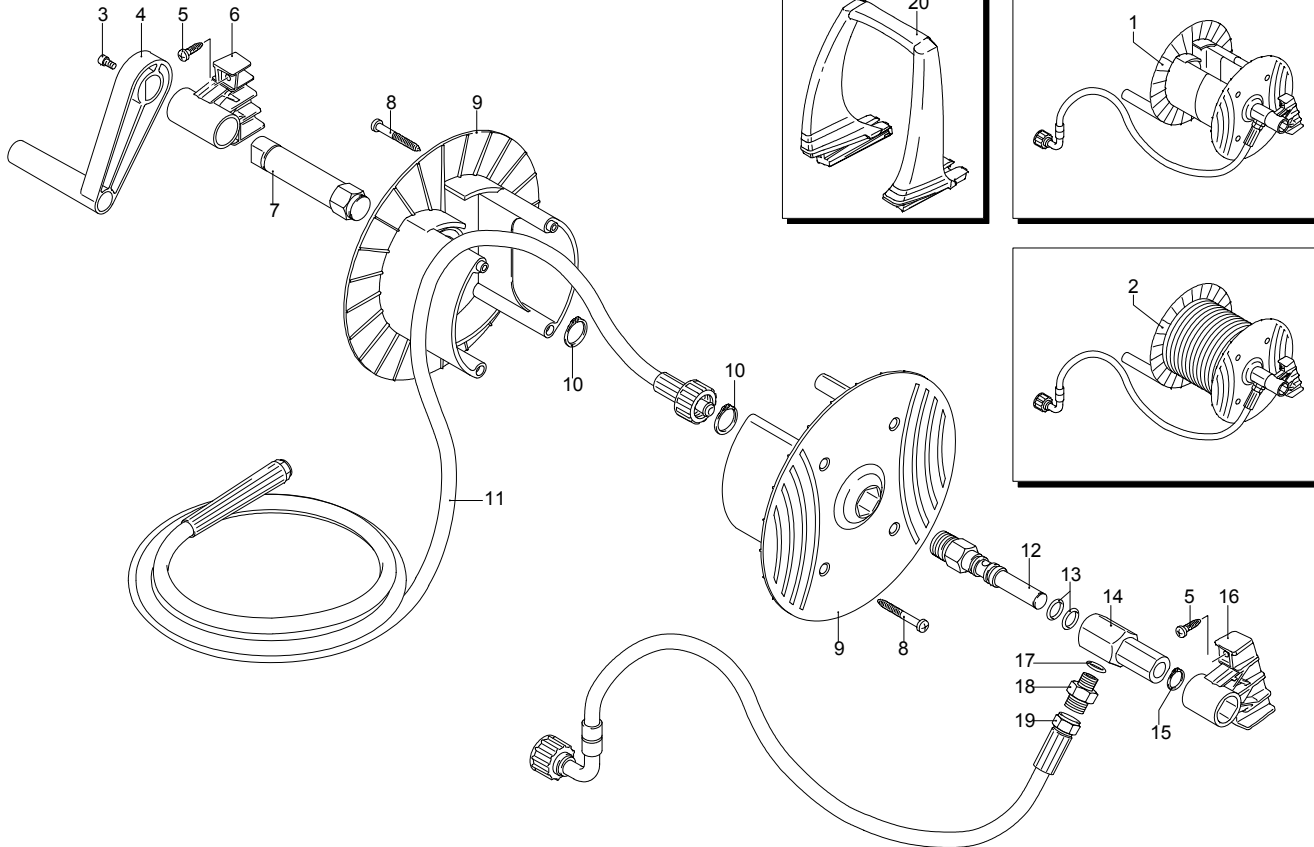

Pos.	Code	Bezeichnung	Menge
1	40644	Vormontage Schlauchhaspel	1
2	40377	Vormontage Schlauchhaspel	1
3	2360360	Schraube	1
4	2360150	Hebel	1
5	2100300	Schraube	4
6	2500060	Bügel	1
7	2500360	Zapfen	1
8	1681280	Schraube	4
9	2360230	Scheibe	2
10	380420	Ring	2
11	2500460	Hochdruckschlauch	1
12	2360210	Zapfen	1
13	390080	O-Ring-Dichtung	2
14	2360220	Verbindungsstück	1
15	2360320	Ring	1
16	2500070	Bügel	1
17	820510	O-Ring-Dichtung	1
18	2360310	Verbindungsstück	1
19	2360250	Hochdruckschlauch	1
20	2500020	Griff	1

UN\_CE\_0078-BX

# Modelle 737 RLW

Seriennummer:

Code:



Elektrischeanschluss:

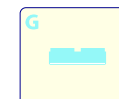
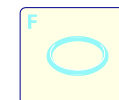
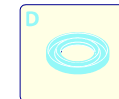
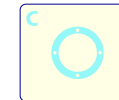
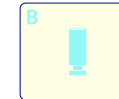
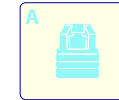
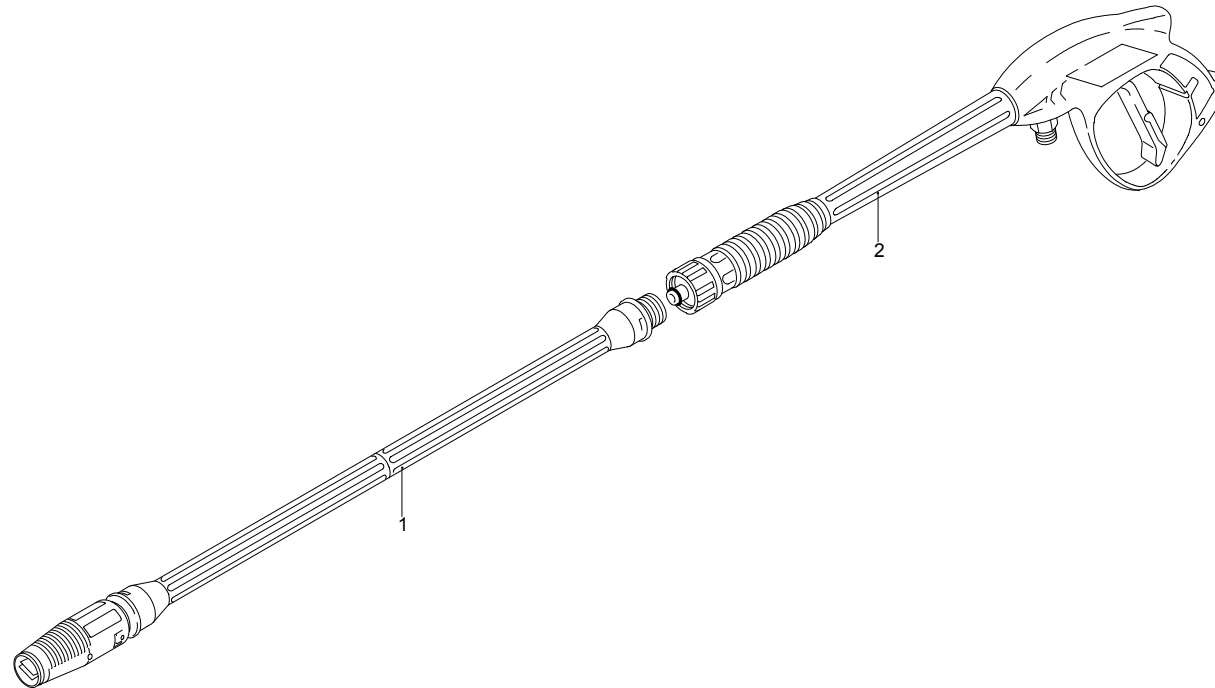

Pos.	Code	Bezeichnung	Menge
1	40206	Lanze+Düsenkopf	1
2	40171	Pistole	1