

Modelle 975 RLW

Seriennummer:

Code:



Elektrischeanschluss:

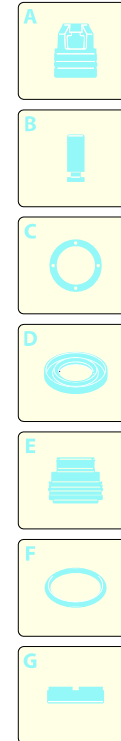
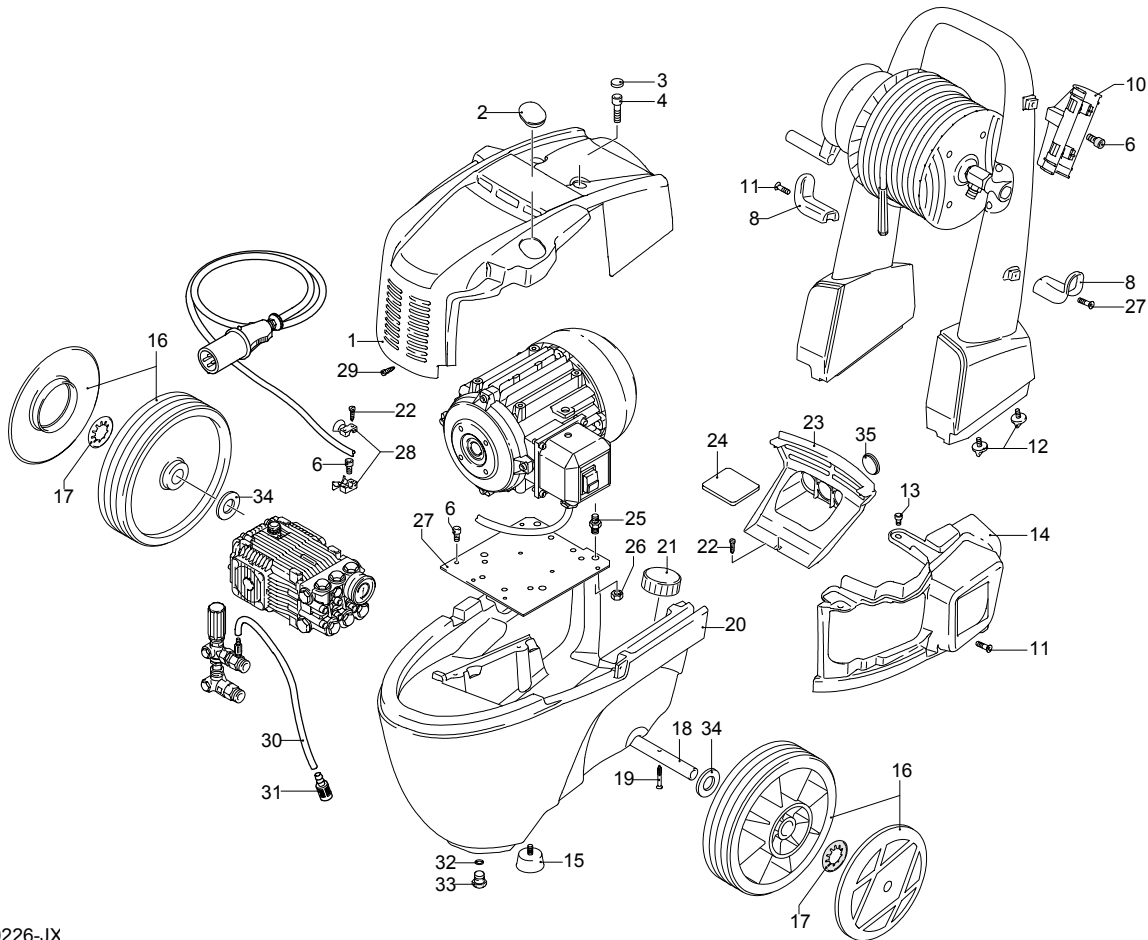

Pos.	Code	Bezeichnung	Menge
1	2360542	Dunkelblaue Haube	1
2	1461820	Verschluss	1
3	1270910	Verschluss	2
4	850250	Schraube	2
6	2360360	Schraube	7
8	2360090	Haken	1
10	2360100	Halterung	1
11	2100300	Schraube	3
12	2360720	Knauf	4
13	850250	Schraube	2
14	2360552	Dunkelblaue Haube	1
15	2360780	Schwingungsdämpfer	2
16	2360571	Rad	2
17	380620	Unterlegscheibe	2
18	2360560	Achse	1
19	1470220	Schraube	2
20	2360010	Basis	1
21	91680930	Verschluss	1
22	2000110	Schraube	3
23	2360040	Schwarze Haube	1
24	2360370	Dichtung	1
25	2360580	Stiftbolzen	4
26	380240	Ring	4
27	2360052	Platte	1
28	2360110	Klemme	1
29	2360710	Schraube	1
30	1270960	Reinigungsmittelschlauch	1
31	2000230	Filter	1
32	2000240	O-Ring-Dichtung	1
33	1682420	Verschluss	1
34	380570	Unterlegscheibe	2
35	2360880	Verschluss	3

Modelle 975 RLW

Seriennummer:

Code:



Elektrischeanschluss:

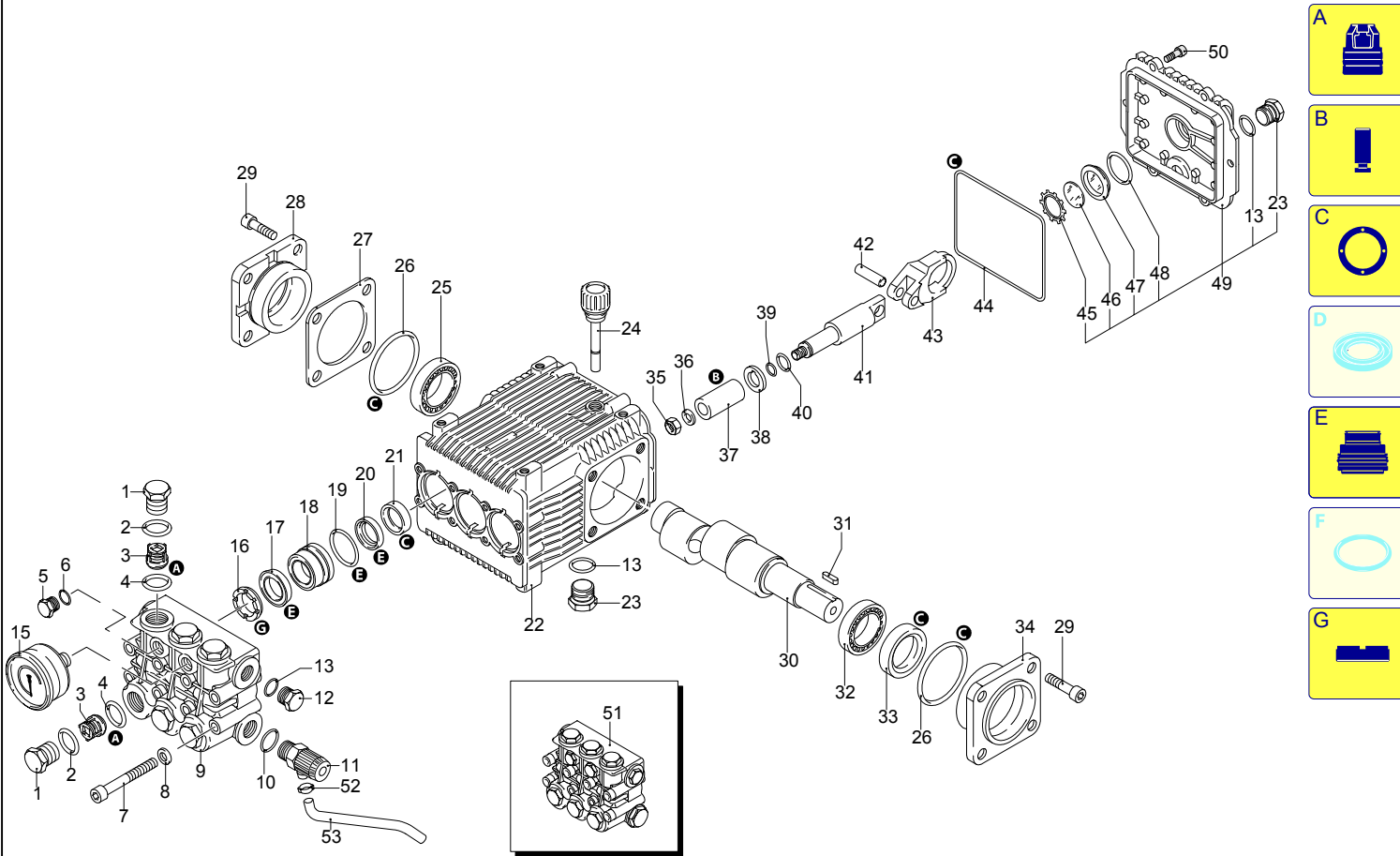

UN_CE_0221-JX

Pos.	Code	Bezeichnung	Menge
1	960850	Verschluss	6
2	960160	O-Ring-Dichtung	6
3	1389051	Ventil	6
4	880830	O-Ring-Dichtung	6
5	1380690	Verschluss	2
6	820510	O-Ring-Dichtung	2
7	820150	Schraube	8
8	1381850	Unterlegscheibe	8
9	1381070	Kopf	1
10	180101	O-Ring-Dichtung	1
11	50129	Ventil	1
12	1381180	Verschluss	1
13	740290	O-Ring-Dichtung	3
15	1381580	Manometer	1
16	960110	Ring	3
17	880320	Wasserdichtung	3
18	1380090	Kolbenführung	3
19	961240	O-Ring-Dichtung	3
20	880330	Wasserdichtung	3
21	1383130	Öldichtung	3
22	1382770	Pumpenkörper	1
23	1980740	Verschluss	2
24	880130	Verschluss	1
25	2280240	Lager	1
26	640030	O-Ring-Dichtung	2
27	1382810	Zwischenstück 0,05 mm	1
27	1380120	Zwischenstück 0,10 mm	1
27	1380530	Zwischenstück 0,25 mm	1
27	1380130	Zwischenstück 0,20 mm	1
28	1380050	Halterung	1
29	850370	Schraube	8
30	2280070	Welle	1
31	1380520	Splint	1
32	840370	Lager	1
33	180340	Dichtung	1
34	1380040	Halterung	1
35	962010	Mutter	3
36	962000	Unterlegscheibe	3
37	1380940	Kolben	3
38	1380950	Scheibe	3
39	600180	O-Ring-Dichtung	3
40	1080401	Ring	3
41	1380920	Stange	3
42	1380060	Stecker	3
43	1383020	Pleuelstange	3
44	1780510	O-Ring-Dichtung	1
45	1260430	Ring	1
46	1780690	Scheibe	1
47	1260250	Füllstandanzeige	1
48	1140450	O-Ring-Dichtung	1
49	1789010	Deckel	1
50	1343510	Schraube	6
51	1389271	Vormontage Kopf	1
52	2020940	Schelle	1
53	1270960	Reinigungsmittelschlauch	1
A	2864	Satz Ventile	1
B	2757	Satz Kolben	1
C	1855	Satz Öldichtungen	1
E	1857	Satz Wasserdichtungen	1
G	1829	Satz Stützringe	1

Modelle 975 RLW

Seriennummer:

Code:



Elektrischeanschluss:

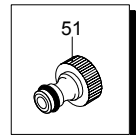
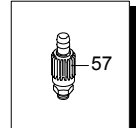
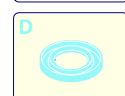
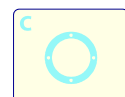
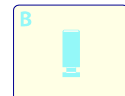
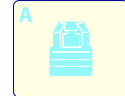
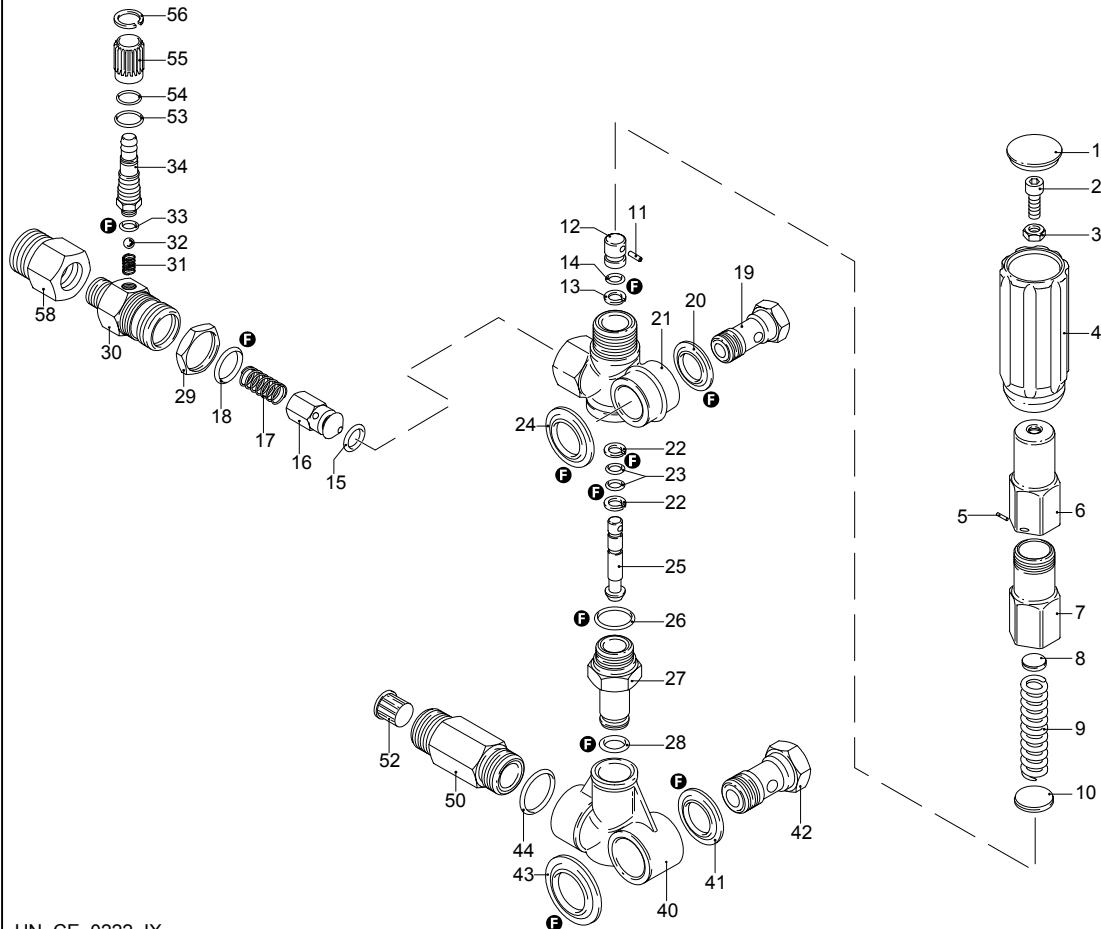

UN_CE_0222-JX

Pos.	Code	Bezeichnung	Menge
1	1560580	Verschluss	1
2	320360	Schraube	1
3	1660210	Mutter	1
4	1560400	Drehknopf	1
5	1080070	Stecker	1
6	1560420	Schraube	1
7	1560410	Führung	1
8	1560440	Teller	1
9	1560350	Feder	1
10	1080610	Teller	1
11	1080660	Stecker	1
12	1080540	Kolben	1
13	391000	O-Ring-Dichtung	1
14	1080640	Ring	1
15	1560150	O-Ring-Dichtung	1
16	1560100	Verschluss	1
17	1560140	Feder	1
18	180101	O-Ring-Dichtung	1
19	1540080	Verbindungsstück	1
20	1540110	Unterlegscheibe	1
21	1560010	Ventilkörper	1
22	1080550	Ring	2
23	480480	O-Ring-Dichtung	2
24	1560280	Unterlegscheibe	1
25	1560320	Kolben	1
26	880270	O-Ring-Dichtung	1
27	1560051	Verbindungsstück	1
28	390080	O-Ring-Dichtung	1
29	1560510	Mutter	1
30	1560530	Verbindungsstück	1
31	1560520	Feder	1
32	1250280	Kugel	1
33	480480	O-Ring-Dichtung	1
34	1560670	Schlauchanschluss	1
40	1540020	Ansaugstück	1
41	1540120	Unterlegscheibe	1
42	1540090	Verbindungsstück	1
43	1560290	Unterlegscheibe	1
44	480440	O-Ring-Dichtung	1
50	1560900	Verbindungsstück	1
51	40393	Verbindungsstück	1
52	1340260	Filter	1
53	800560	O-Ring-Dichtung	1
54	480560	O-Ring-Dichtung	1
55	1560680	Drehknopf	1
56	1560660	Ring	1
57	1569202	Vormontage IDR	1
58	1123960	Verbindungsstück	1
F	2611	Satz Dichtungen	1

Modelle 975 RLW

Seriennummer:

Code:



Elektrischeanschluss:

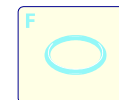
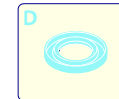
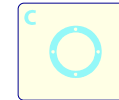
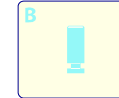
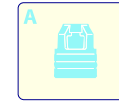
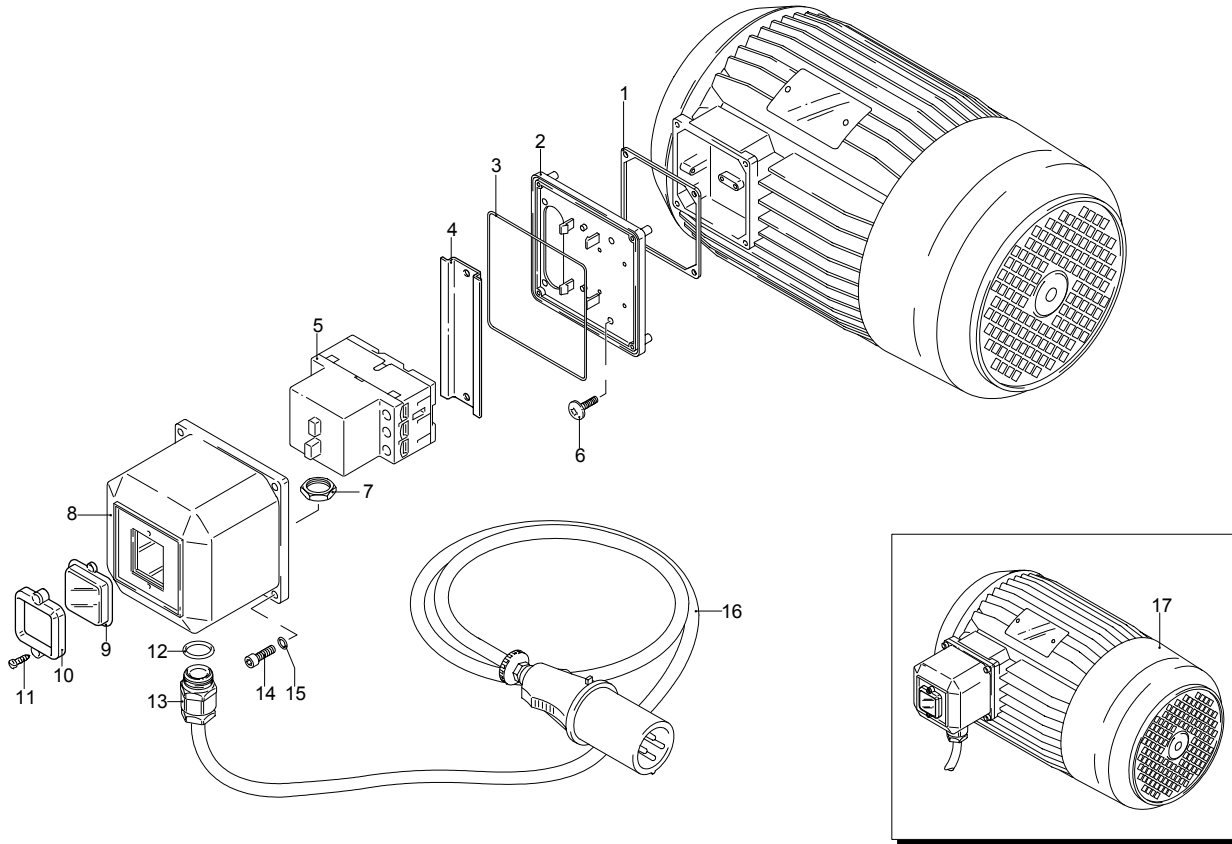

Pos.	Code	Bezeichnung	Menge
1	1700110	O-Ring-Dichtung	1
2	1700080	Platte	2
3	1940410	O-Ring-Dichtung	1
4	1381950	Halterung	1
5	1382060	Schalter	1
6	1470130	Schraube	4
7	1700590	Mutter	1
8	1700090	Deckel	1
9	1700130	Schutzkasten	1
10	1700120	Umrandung	1
11	1261560	Schraube	6
12	880270	O-Ring-Dichtung	1
13	1382380	Kabelverschraubung	1
14	1261560	Schraube	4
15	1080190	O-Ring-Dichtung	4
16	1381640	Kabel	1
17	44328	Motor	1

Modelle 975 RLW

Seriennummer:

Code:



Elektrischeanschluss:

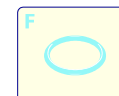
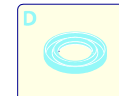
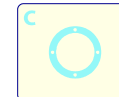
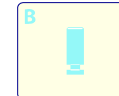
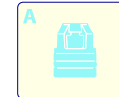
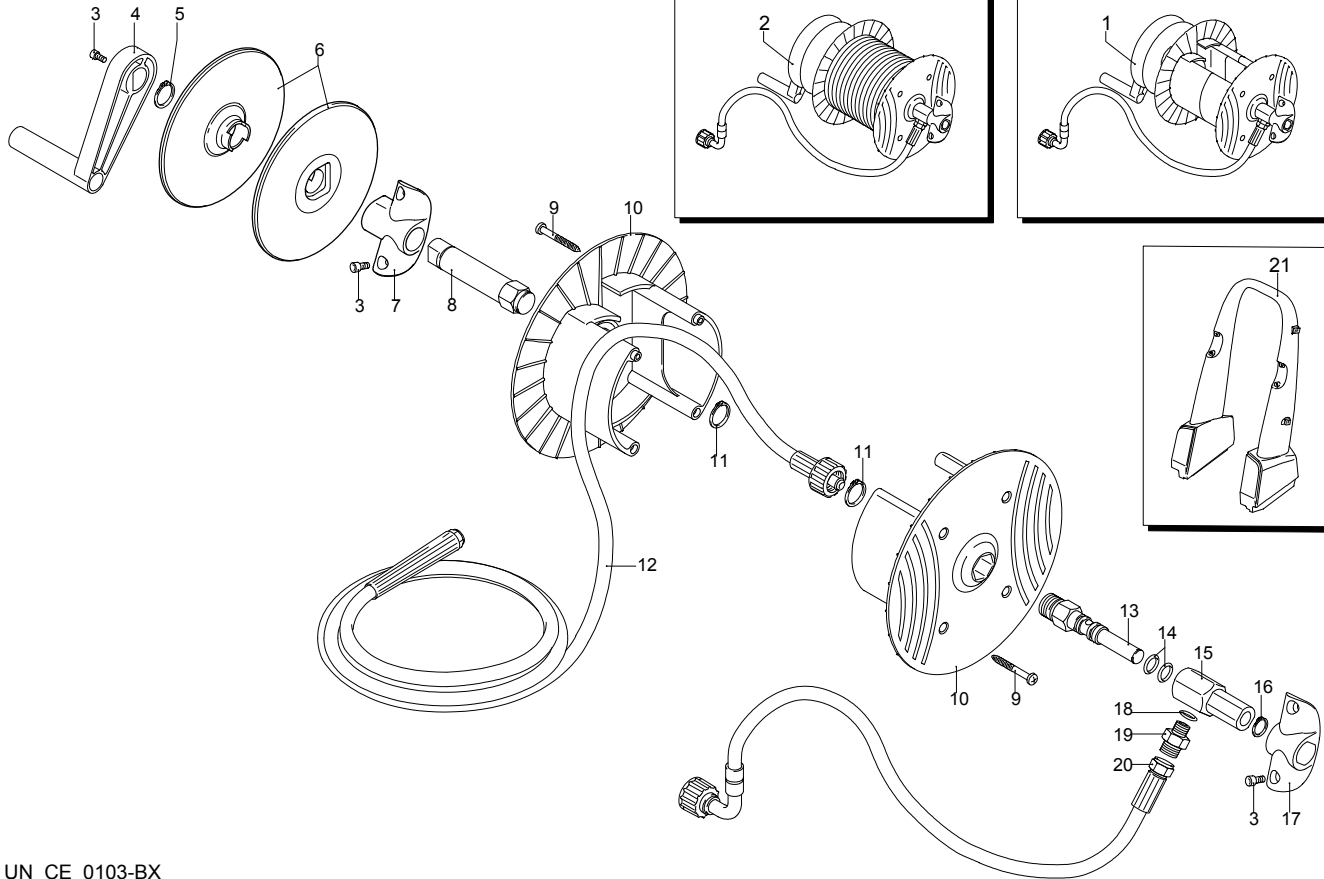

Pos.	Code	Bezeichnung	Menge
1	40646	Vormontage Schlauchhaspel	1
2	40681	Vormontage Schlauchhaspel	1
3	2360360	Schraube	1
4	2360150	Hebel	2
5	650500	Ring	1
6	2360190	Scheibe	1
7	2360160	Bügel	1
8	2360280	Zapfen	1
9	1681280	Schraube	4
10	2360230	Scheibe	2
11	380420	Ring	2
12	2360260	Hochdruckschlauch	1
13	2360210	Zapfen	1
14	390080	O-Ring-Dichtung	2
15	2360220	Verbindungsstück	1
16	2360320	Ring	1
17	2360080	Bügel	1
18	820510	O-Ring-Dichtung	1
19	2360310	Verbindungsstück	1
20	2360250	Hochdruckschlauch	1
21	2360020	Griff	1

UN_CE_0103-BX

Modelle 975 RLW

Seriennummer:

Code:



Elektrischeanschluss:

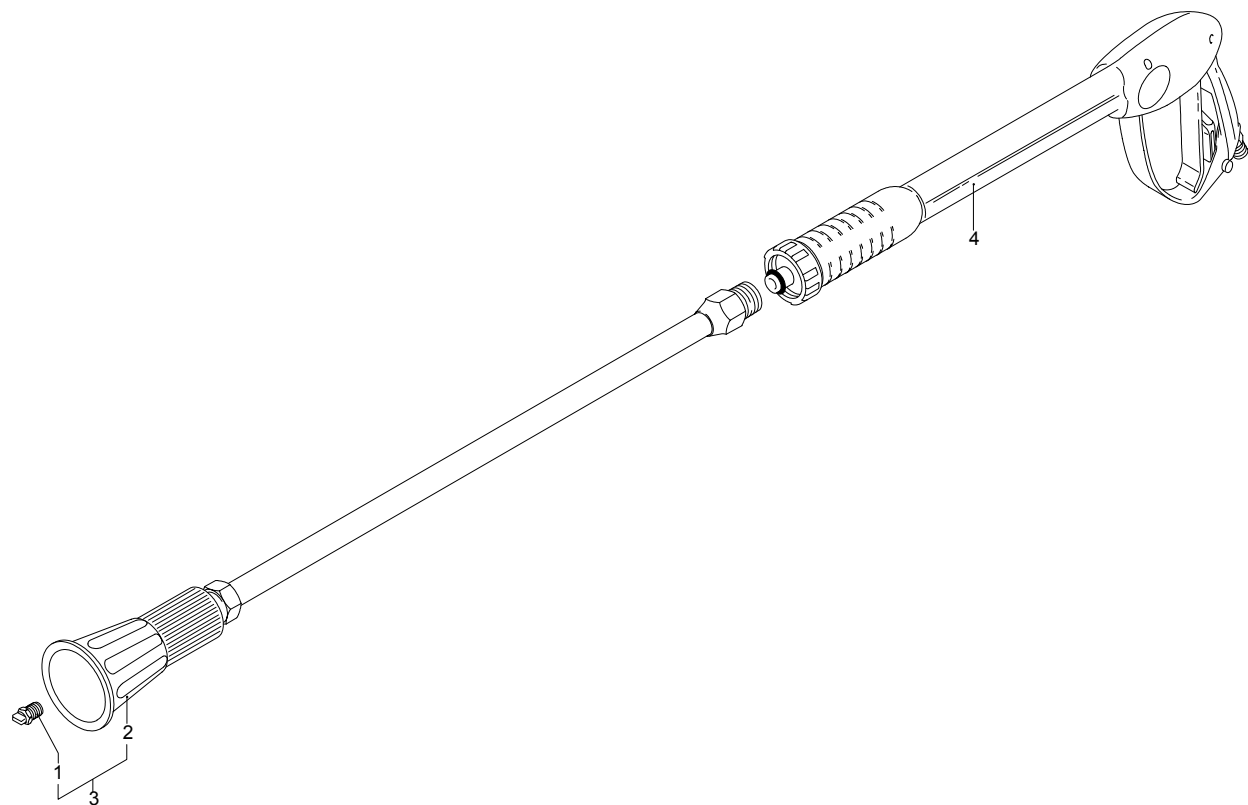

UN_CE_0124-BX

Pos.	Code	Bezeichnung	Menge
1	3086	Düse	1
2	40541	Lanze+Düsenkopf ohne Düse	1
3	40651	Lanze+Düsenkopf	1
4	40770	Pistole	1