



MIRAGE 120 TSS 2 SPEED

Ausführung:

Seriennummer:

Code: **12223**

 230 V - 50 Hz

 schuko

| Gültigkeit | Pos. | Code | Bezeichnung | Menge |
|------------|------|---------|----------------|-------|
| | 1 | 2560380 | Drehknopf | 1 |
| | 2 | 2560490 | Stecker | 1 |
| | 3 | 2860010 | Gelbe Haube | 1 |
| | 4 | 2440070 | Rad | 2 |
| | 5 | 2100300 | Schraube | 16 |
| | 6 | 2860170 | Schwarze Haube | 1 |
| | 7 | 2860160 | Schwarze Haube | 1 |

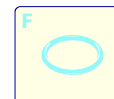
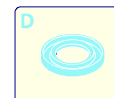
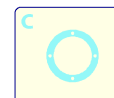
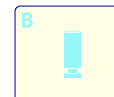
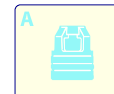
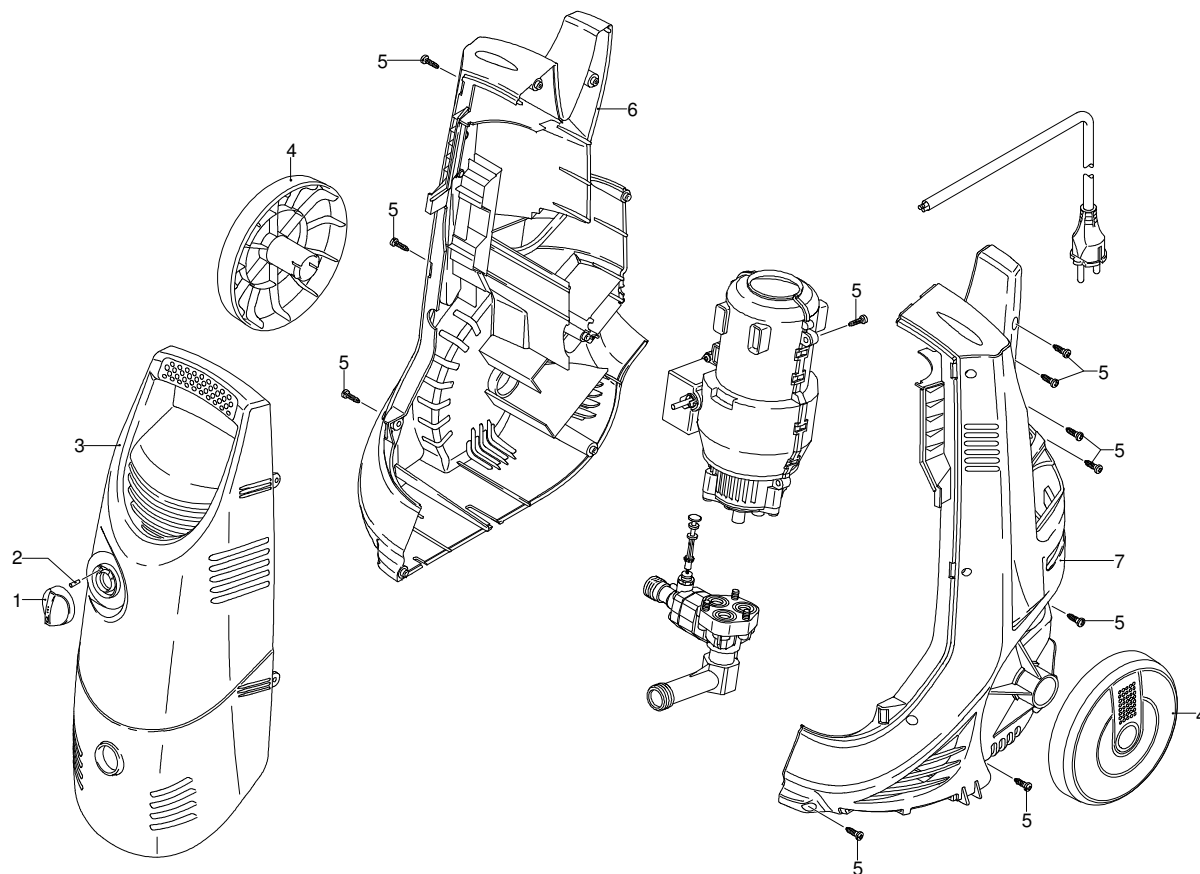

MIRAGE 120 TSS 2 SPEED

Ausführung:

Seriennummer:

Code: **12223**

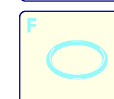
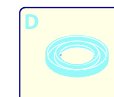
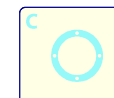
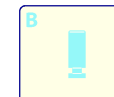
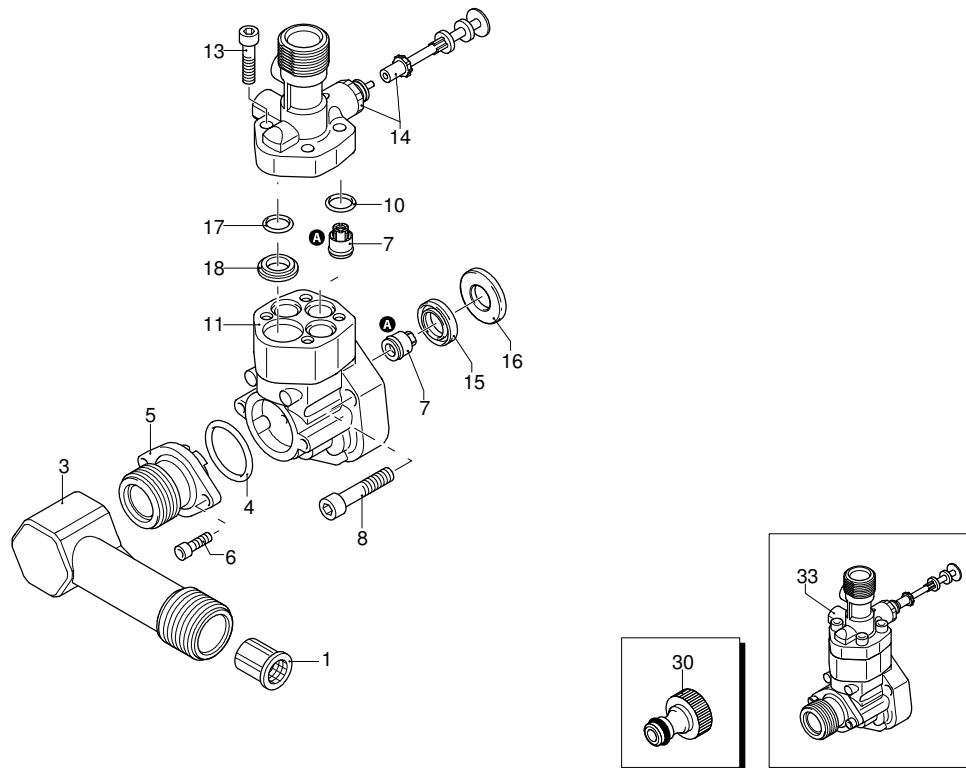
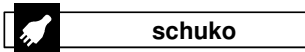
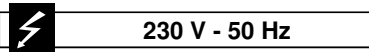

| Gültigkeit | Pos. | Code | Bezeichnung | Menge |
|------------|------|---------|-----------------------------|-------|
| | 1 | 1340260 | Filter | 1 |
| | 3 | 2569000 | Verbindungsstück | 1 |
| | 4 | 550350 | O-Ring-Dichtung | 1 |
| | 5 | 2100540 | Verbindungsstück | 1 |
| | 6 | 2101000 | Schraube | 2 |
| | 7 | 2109050 | Ventil | 6 |
| | 8 | 850850 | Schraube | 3 |
| | 10 | 880840 | O-Ring-Dichtung | 3 |
| | 11 | 2100550 | Kopf | 1 |
| | 13 | 1260760 | Schraube | 4 |
| | 14 | 42012 | Vormontage Verbindungsstück | 1 |
| | 15 | 2200141 | Wasserdichtung | 3 |
| | 16 | 2020041 | Ring | 3 |
| | 17 | 394280 | O-Ring-Dichtung | 1 |
| | 18 | 2560480 | Buchse | 1 |
| | 30 | 1461470 | Verbindungsstück | 1 |
| | 33 | 2208 | Vormontage Kopf | 1 |
| | A | 2574 | Satz Ventile | 1 |

MIRAGE 120 TSS 2 SPEED

Ausführung:

Seriennummer:

Code: **12223**

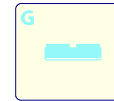
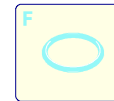
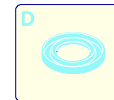
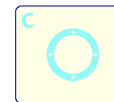
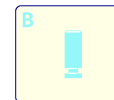
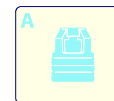
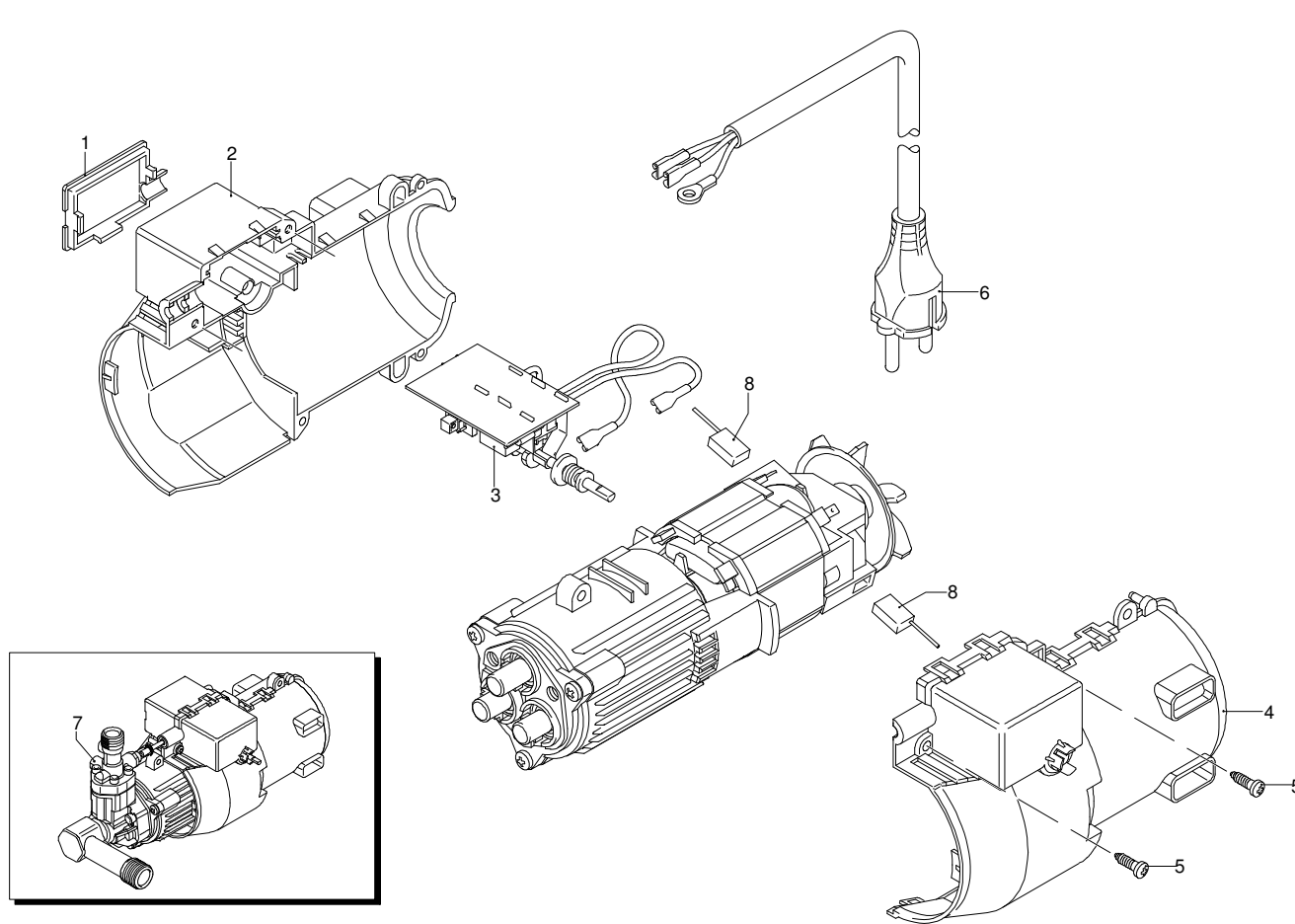
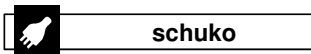
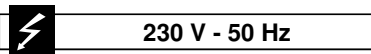

| Gültigkeit | Pos. | Code | Bezeichnung | Menge |
|------------|------|---------|-------------------------|-------|
| | 1 | 2560350 | Deckel | 1 |
| | 2 | 2560130 | Leitblech | 1 |
| | 3 | 2560400 | Schalter | 1 |
| | 4 | 2560120 | Leitblech | 1 |
| | 5 | 2100300 | Schraube | 2 |
| | 6 | 2560900 | Kabel | 1 |
| | 7 | 2569559 | Vormontage Elektropumpe | 1 |
| | 8 | 2260 | Bürstesatz für Motor | 1 |

MIRAGE 120 TSS 2 SPEED

Ausführung:

Seriennummer:

Code: **12223**

 **230 V - 50 Hz**

 **schuko**

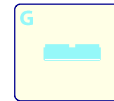
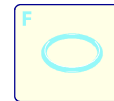
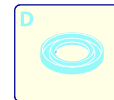
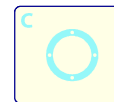
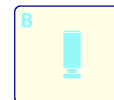
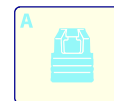
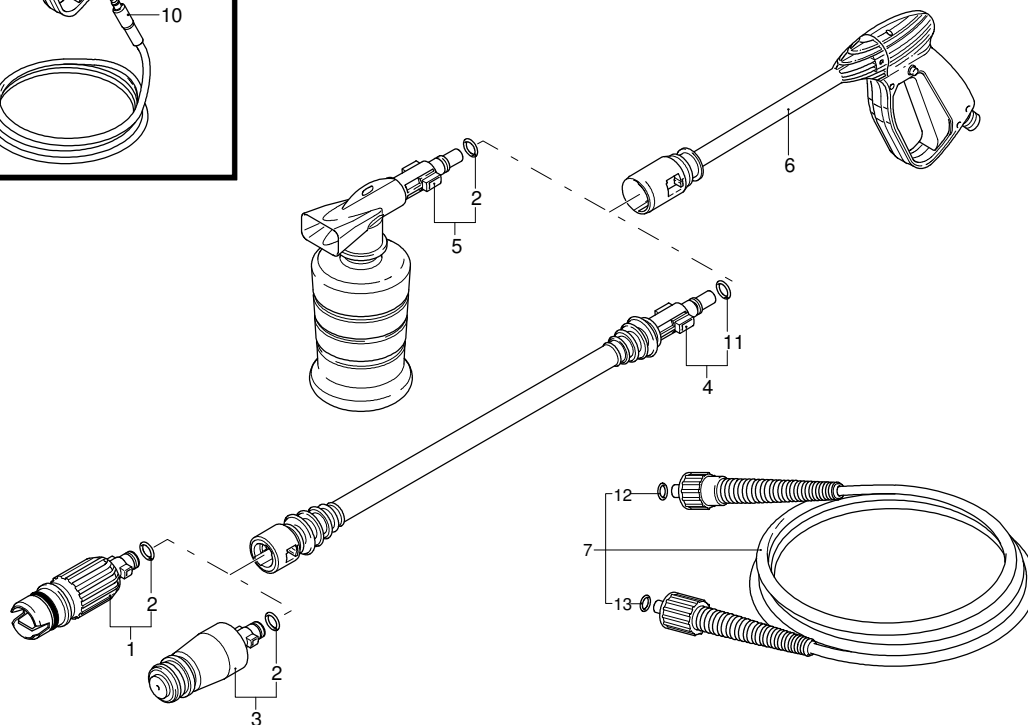
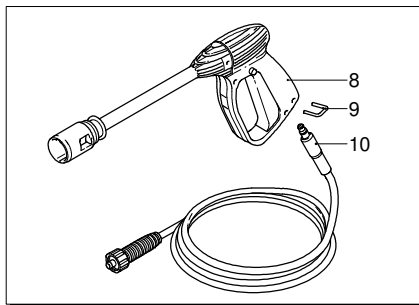

| Gültigkeit | Pos. | Code | Bezeichnung | Menge |
|-------------|------|---------|---------------------|-------|
| | 1 | 40668 | Düsenkopf | 1 |
| | 2 | 1680220 | O-Ring-Dichtung | 3 |
| | 3 | 40343 | Düsenkopf Rotopower | 1 |
| | 4 | 40667 | Lanze | 1 |
| | 5 | 40352 | Tank | 1 |
| | 6 | 40666 | Pistole | 1 |
| I---> 01-07 | 7 | 2620400 | Hochdruckschlauch | 1 |
| I---> 01-07 | 8 | 40409 | Pistole | 1 |
| ---> 12-06 | 9 | 2000080 | Klemme | 1 |
| ---> 12-06 | 10 | 2000420 | Hochdruckschlauch | 1 |
| ---> 12-06 | 11 | 880840 | O-Ring-Dichtung | 1 |
| | 12 | 1080250 | O-Ring-Dichtung | 1 |
| | 13 | 2000770 | O-Ring-Dichtung | 1 |