

PROLINER RS 15.15 TSS RLW

Ausführung:

Seriennummer:

Code: **22674**

 **400 V - 50 Hz - 3 ~**

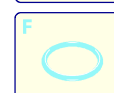
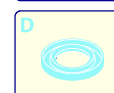
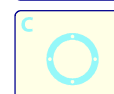
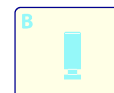
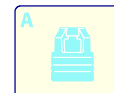
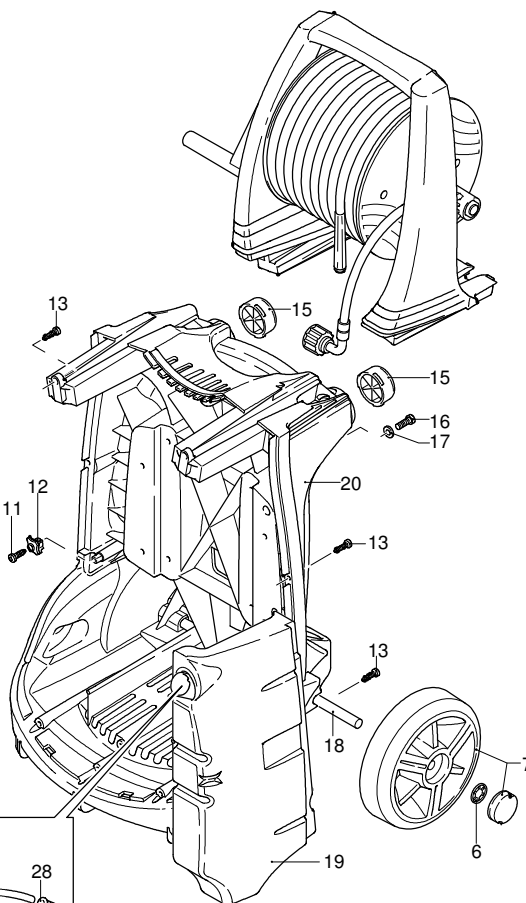
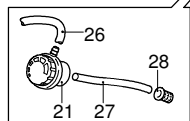
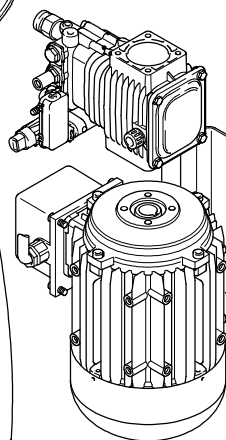
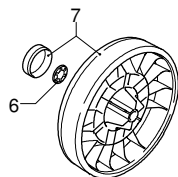
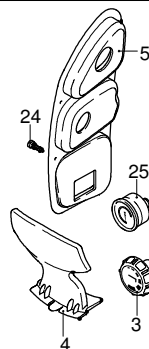
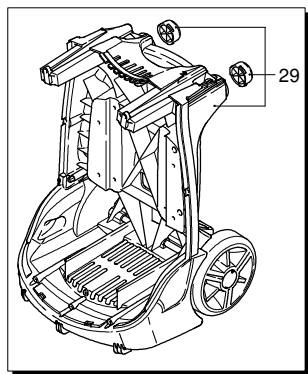

Gültigkeit	Pos.	Code	Bezeichnung	Menge
	1	2500371	Gelbe Haube	1
	3	2500310	Knauf	1
	4	2500050	Haken	1
	5	2500380	Haubeneinsatz	1
	6	1680880	Unterlegscheibe	2
	7	2500320	Rad	2
	9	2500410	Platte	1
	10	850370	Schraube	4
	11	2100300	Schraube	1
	12	2600100	Kabelverschraubung	1
	13	2100300	Schraube	7
	15	2500130	Gummifuß	2
	16	880280	Schraube	4
	17	2180300	Unterlegscheibe	4
	18	2500120	Achse	1
	19	2500110	Tank	1
	20	2500010	Basis	1
	21	42113	Vormontage Verschluss	1
	22	1261560	Schraube	2
	23	2500440	Schutzeinrichtung	1
	24	2000110	Schraube	4
	25	3232	Manometer	1
	26	2500330	Reinigungsmittelschlauch	1
	27	2500330	Reinigungsmittelschlauch	1
	28	2000230	Filter	1
	29	2509000	Basis Vormontage	1

PROLINER RS 15.15 TSS RLW

Ausführung:

Seriennummer:

Code: **22674**

 **400 V - 50 Hz - 3 ~**

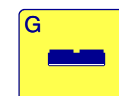
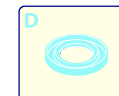
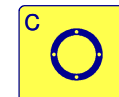
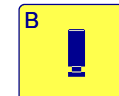
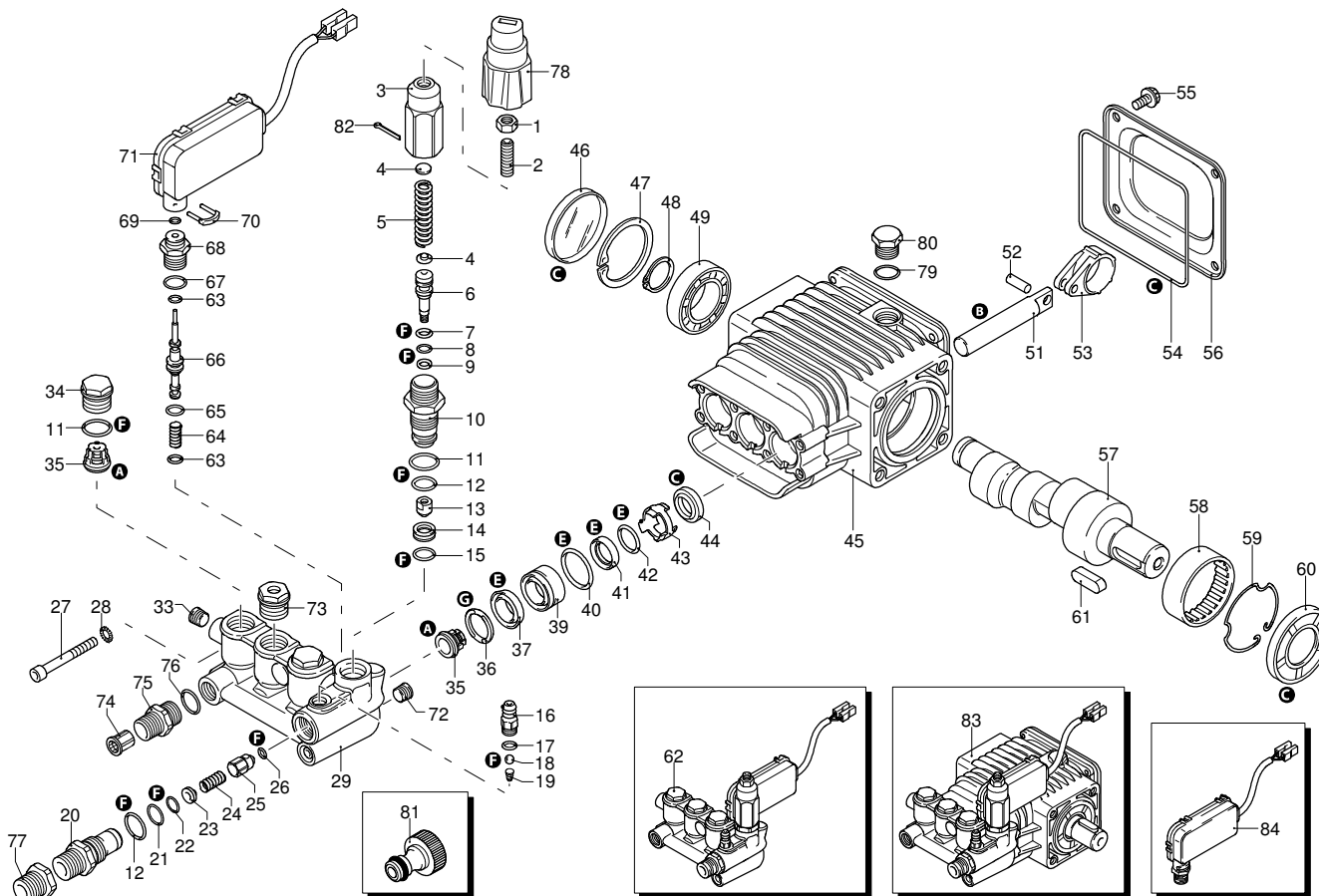

UN_CE_0109-MW

Gültigkeit	Pos.	Code	Bezeichnung	Menge
	1	1980300	Mutter	1
	2	1980470	Schraube	1
	3	2760700	Einsatz	1
	4	1980220	Teller	2
	5	2760410	Feder	1
	6	2760400	Stange	1
	7	2260100	O-Ring-Dichtung	1
	8	660190	O-Ring-Dichtung	1
	9	2760210	Ring	1
	10	2760570	Führung	1
	11	1200690	O-Ring-Dichtung	4
	12	394280	O-Ring-Dichtung	2
	13	2260070	Verschluss	1
	14	2760090	Sitz	1
	15	770140	O-Ring-Dichtung	1
	16	1982520	Schlauchanschluss	1
	17	480480	O-Ring-Dichtung	1
	18	1250280	Kugel	1
	19	1560520	Feder	1
	20	2760230	Injektor	1
	21	2760270	O-Ring-Dichtung	1
	22	1470210	O-Ring-Dichtung	1
	23	2760120	Einsatz	1
	24	2760200	Feder	1
	25	2760130	Verschluss	1
	26	1460430	O-Ring-Dichtung	1
	27	801080	Schraube	8
	28	1381550	Unterlegscheibe	8
	29	2760500	Kopf	1
	33	2760260	Verschluss	2
	34	2760180	Verschluss	3
	35	2769050	Ventil	6
	36	1780140	Ring	3
	37	1260220	Wasserdichtung	3
	39	1320351	Kolbenführung	3
	40	1260420	O-Ring-Dichtung	3
	41	1260450	Wasserdichtung	3
	42	480440	O-Ring-Dichtung	3
	43	2760600	Distanzstück	3
	44	2460170	Öldichtung	3
	45	2760460	Pumpenkörper	1
	46	1266740	Öldichtung	1
	47	1260790	Ring	1
	48	1780550	Ring	1
	49	1780490	Lager	1
	51	2760450	Kolben	3
	52	1780050	Stecker	3
	53	1780040	Pleuelstange	3
	54	2760280	O-Ring-Dichtung	1
	55	802190	Schraube	4
	56	2760110	Deckel	1
	57	2760550	Welle	1
	58	1321190	Lager	1
	59	1321080	Ring	1
	60	1260750	Öldichtung	1
	61	650250	Splint	1
	62	2769208	Vormontage Kopf	1
	63	1080190	O-Ring-Dichtung	4
	64	1981320	Feder	1
	65	660190	O-Ring-Dichtung	1
	66	1540881	Stange	1
	67	880840	O-Ring-Dichtung	1

PROLINER RS 15.15 TSS RLW

Ausführung:

Seriennummer:

Code: **22674**

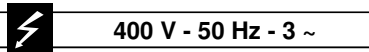

400 V - 50 Hz - 3 ~

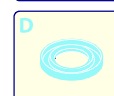
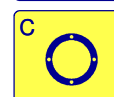
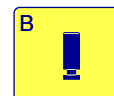
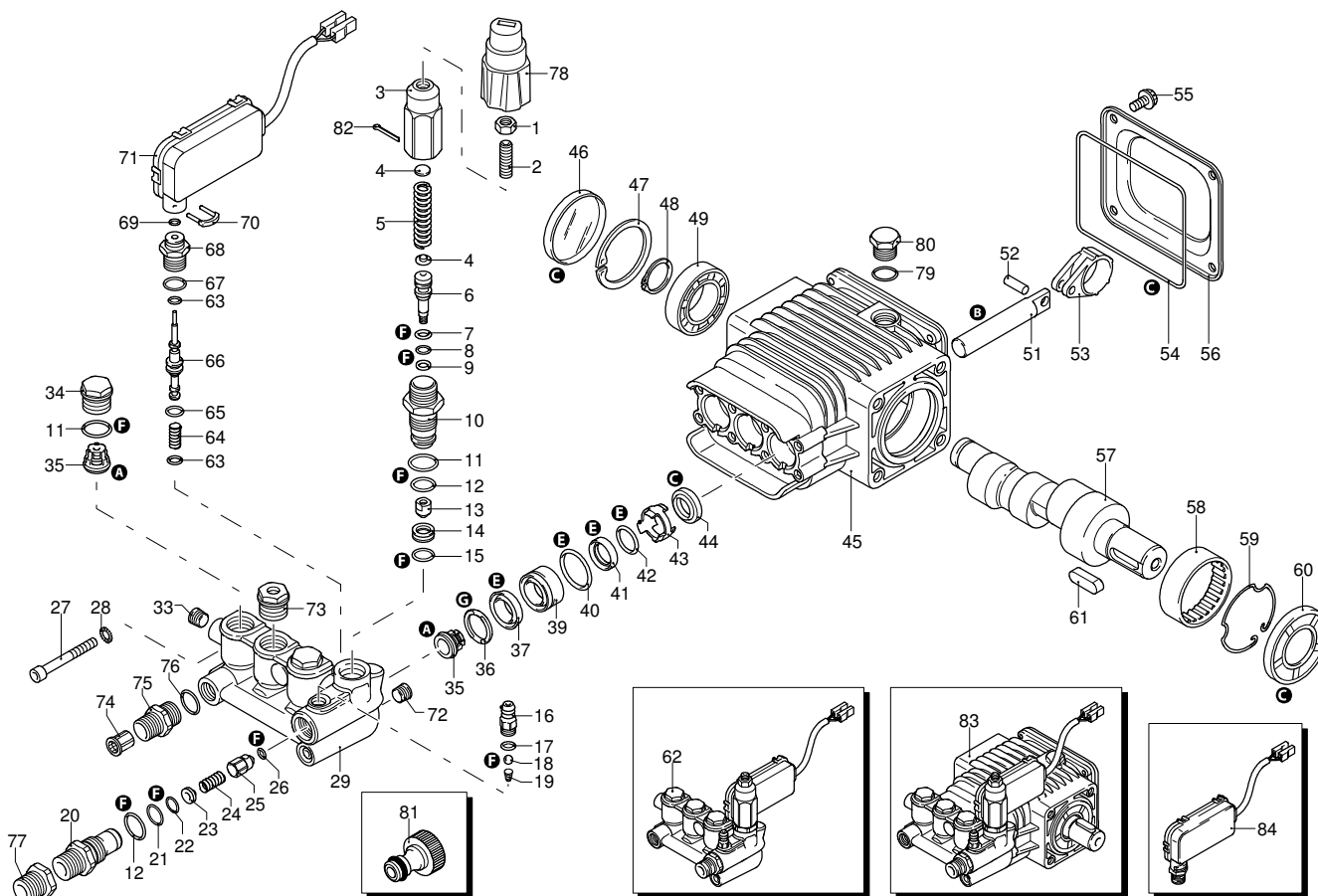
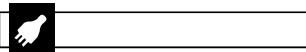

Gültigkeit	Pos.	Code	Bezeichnung	Menge
	68	1540870	Verbindungsstück	1
	69	1260820	O-Ring-Dichtung	1
	70	2022200	Klemme	1
	71	2029758	Vormontage Kasten TSS	1
	72	1981190	Schraube	1
	73	2760560	Verschluss	3
	74	1340260	Filter	1
	75	2500490	Verbindungsstück	1
	76	480440	O-Ring-Dichtung	1
	77	1122260	Verbindungsstück	1
	78	2500210	Drehknopf	1
	79	740290	O-Ring-Dichtung	1
	80	1980740	Verschluss	1
	81	40393	Verbindungsstück	1
	82	2500550	Splintstift	1
	83	22229	Pumpe	1
	84	42458	Satz TSS	1
	A	2186	Satz Ventile	1
	B	42154	Satz Kolben	1
	C	42194	Satz Öldichtungen	1
	E	42155	Satz Wasserdichtungen	1
	G	2745	Satz Stützringe	1
	F	2190	Satz Dichtungen	1

PROLINER RS 15.15 TSS RLW

Ausführung:

Seriennummer:

Code: **22674**

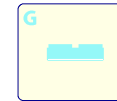
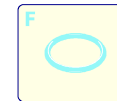
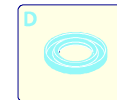
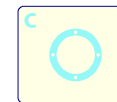
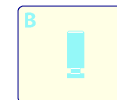
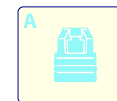
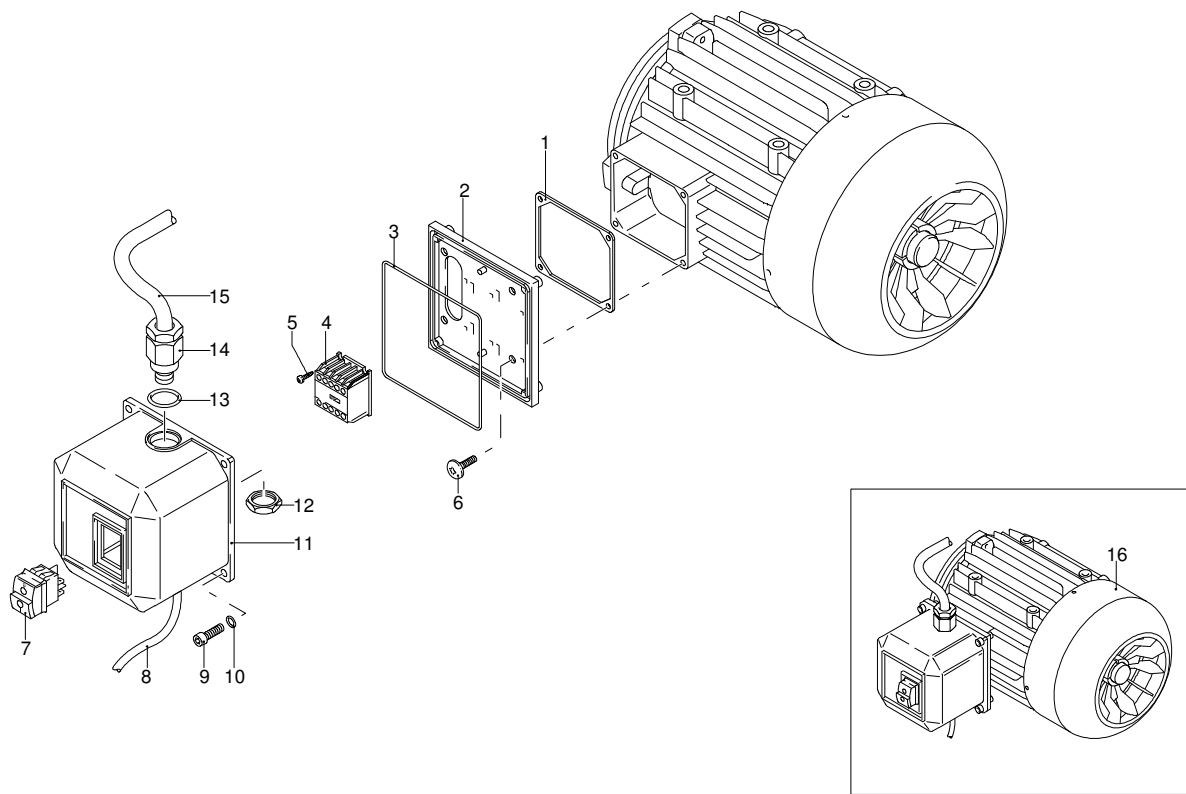
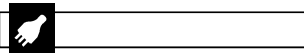

 **400 V - 50 Hz - 3 ~**



Gültigkeit	Pos.	Code	Bezeichnung	Menge
	1	1700100	Dichtung	1
	2	1700080	Platte	1
	3	1940410	O-Ring-Dichtung	1
	4	1700740	Kleinschütz	1
	5	1261570	Schraube	4
	6	1460460	Schraube	4
	7	2320280	Schalter	1
	8	2180650	Kabel	1
	9	1261560	Schraube	4
	10	1080190	O-Ring-Dichtung	4
	11	1700930	Deckel	1
	12	1700590	Mutter	1
	13	880270	O-Ring-Dichtung	1
	14	1382380	Kabelverschraubung	1
	15	1700640	Kabel	1
	16	44079	Motor	1

PROLINER RS 15.15 TSS RLW

Ausführung:
 Seriennummer:
 Code: **22674**

 **400 V - 50 Hz - 3 ~** 

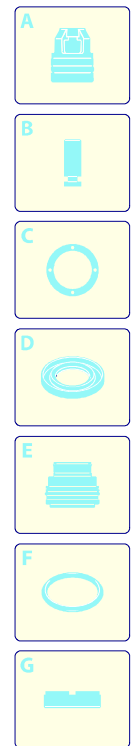
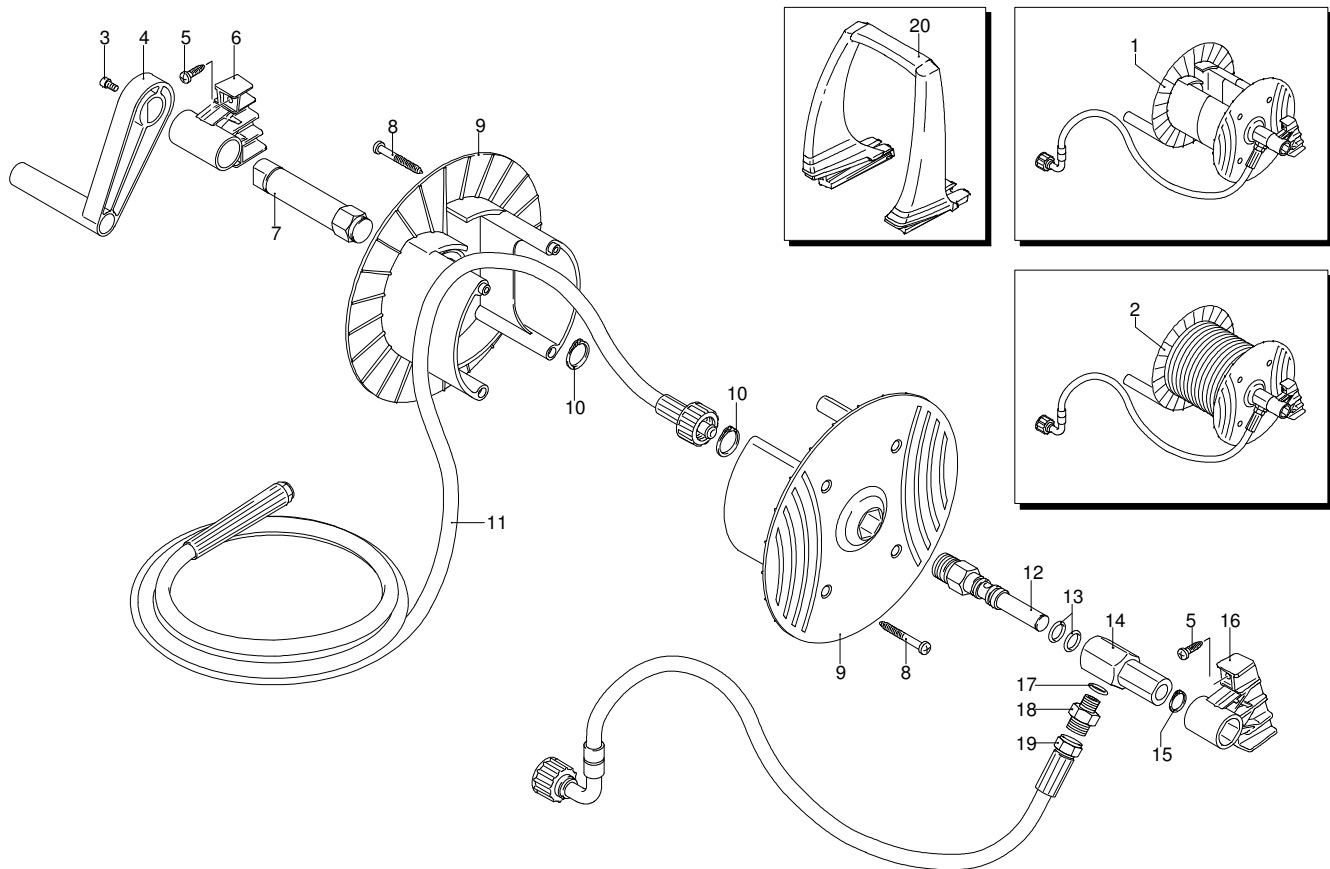

Gültigkeit	Pos.	Code	Bezeichnung	Menge
	1	40644	Vormontage Schlauchhaspel	1
	2	40377	Vormontage Schlauchhaspel	1
	3	2360360	Schraube	1
	4	2360150	Hebel	1
	5	2100300	Schraube	4
	6	2500060	Bügel	1
	7	2500360	Zapfen	1
	8	1681280	Schraube	4
	9	2360230	Scheibe	2
	10	380420	Ring	2
	11	2500460	Hochdruckschlauch	1
	12	2360210	Zapfen	1
	13	390080	O-Ring-Dichtung	2
	14	2360220	Verbindungsstück	1
	15	2360320	Ring	1
	16	2500070	Bügel	1
	17	820510	O-Ring-Dichtung	1
	18	2360310	Verbindungsstück	1
	19	2360250	Hochdruckschlauch	1
	20	2500020	Griff	1

PROLINER RS 15.15 TSS RLW

Ausführung:



Seriennummer:

Code: **22674**

 400 V - 50 Hz - 3 ~

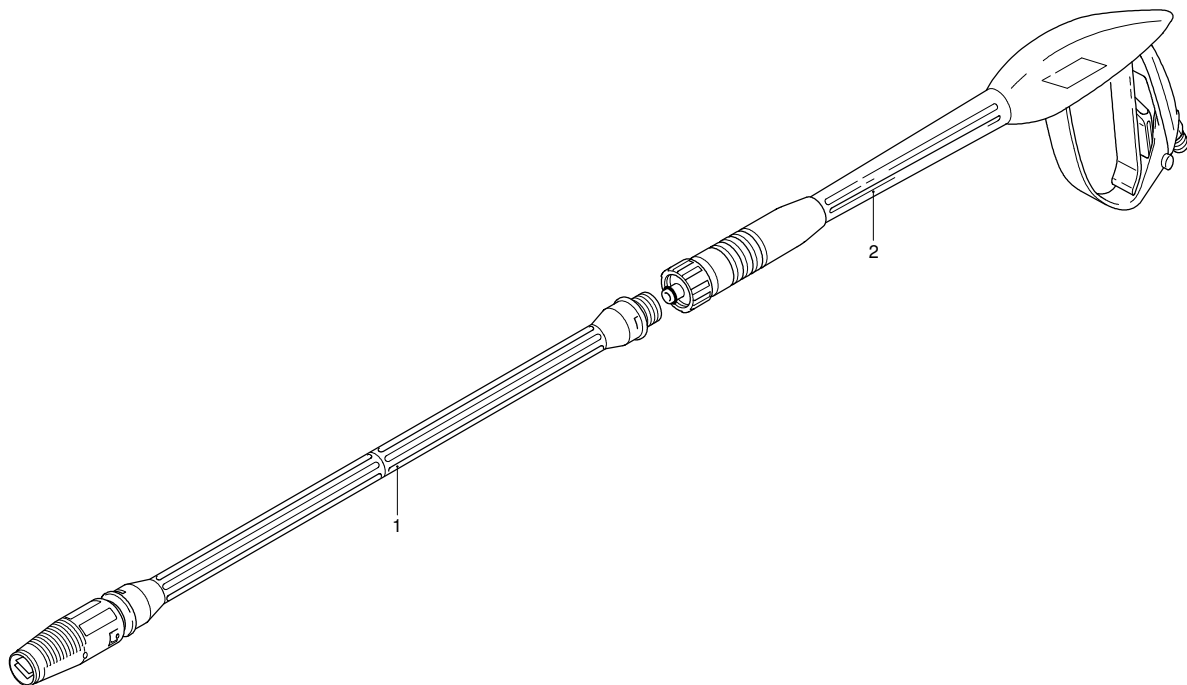

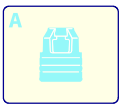
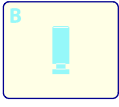
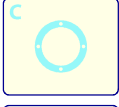
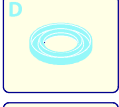
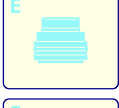

- A 
- B 
- C 
- D 
- E 
- F 
- G 

Gültigkeit	Pos.	Code	Bezeichnung	Menge
	1	40115	Lanze+Düsenkopf	1
	2	41046	Pistole	1