

# PROLINER SV 1510 TSS RLW

Ausführung:

Seriennummer:

Code: **12320**

 **400 V - 50 Hz - 3 ~**

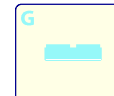
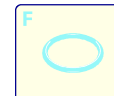
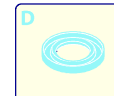
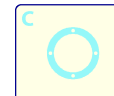
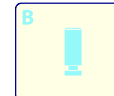
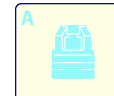
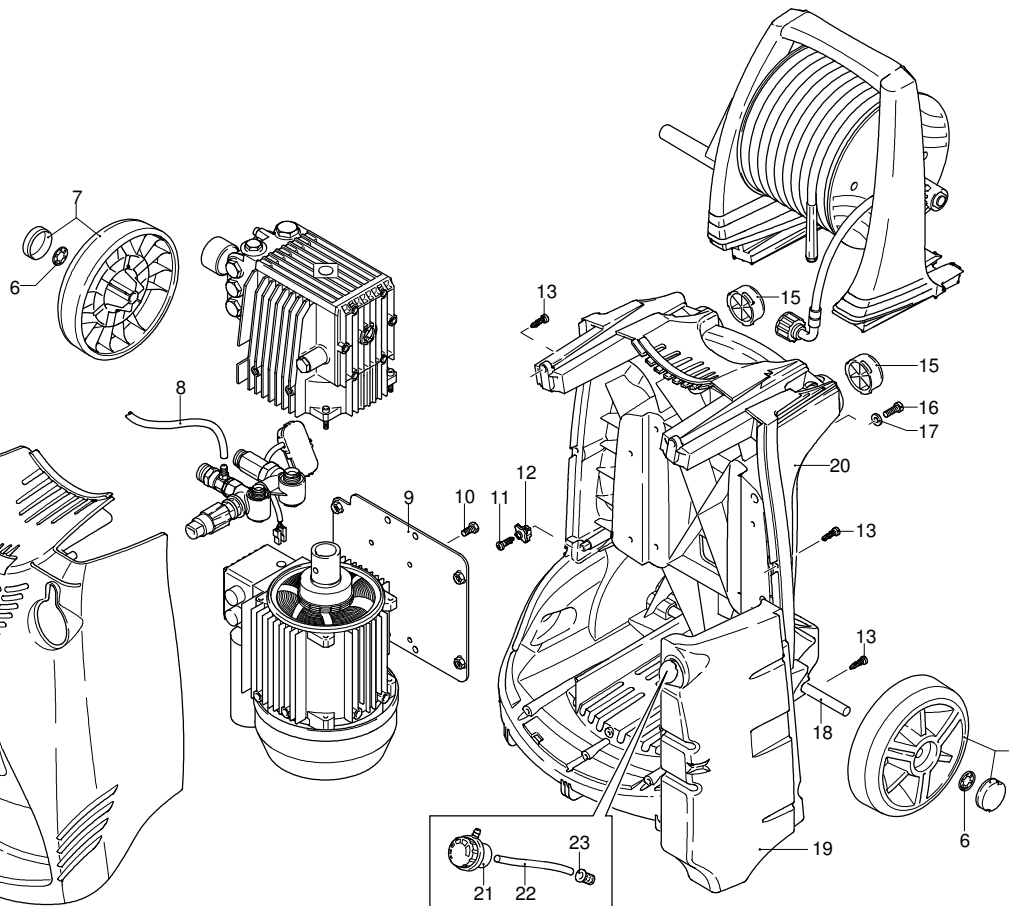
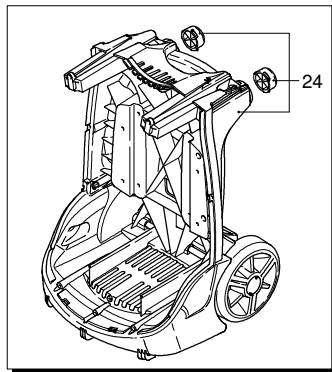

Gültigkeit	Pos.	Code	Bezeichnung	Menge
	1	2500044	Gelbe Haube	1
	2	2500340	Verschluss	1
	3	2500310	Knauf	1
	4	2500050	Haken	1
	5	2500240	Haubeneinsatz	1
	6	1680880	Unterlegscheibe	2
	7	2500320	Rad	2
	8	2500330	Reinigungsmittelschlauch	1
	9	2500100	Platte	1
	10	1260470	Schraube	4
	11	2100300	Schraube	1
	12	2600100	Kabelverschraubung	1
	13	2100300	Schraube	7
	15	2500130	Gummifuß	2
	16	880280	Schraube	4
	17	2180300	Unterlegscheibe	4
	18	2500120	Achse	1
	19	2500110	Tank	1
	20	2500010	Basis	1
	21	42113	Vormontage Verschluss	1
	22	2500330	Reinigungsmittelschlauch	1
	23	2000230	Filter	1
	24	2509000	Basis Vormontage	1

# PROLINER SV 1510 TSS RLW

Ausführung:

Seriennummer:

Code: **12320**

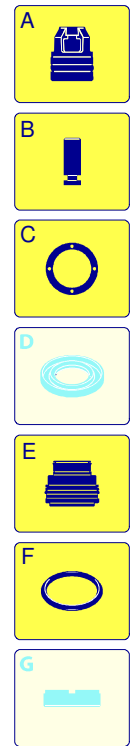
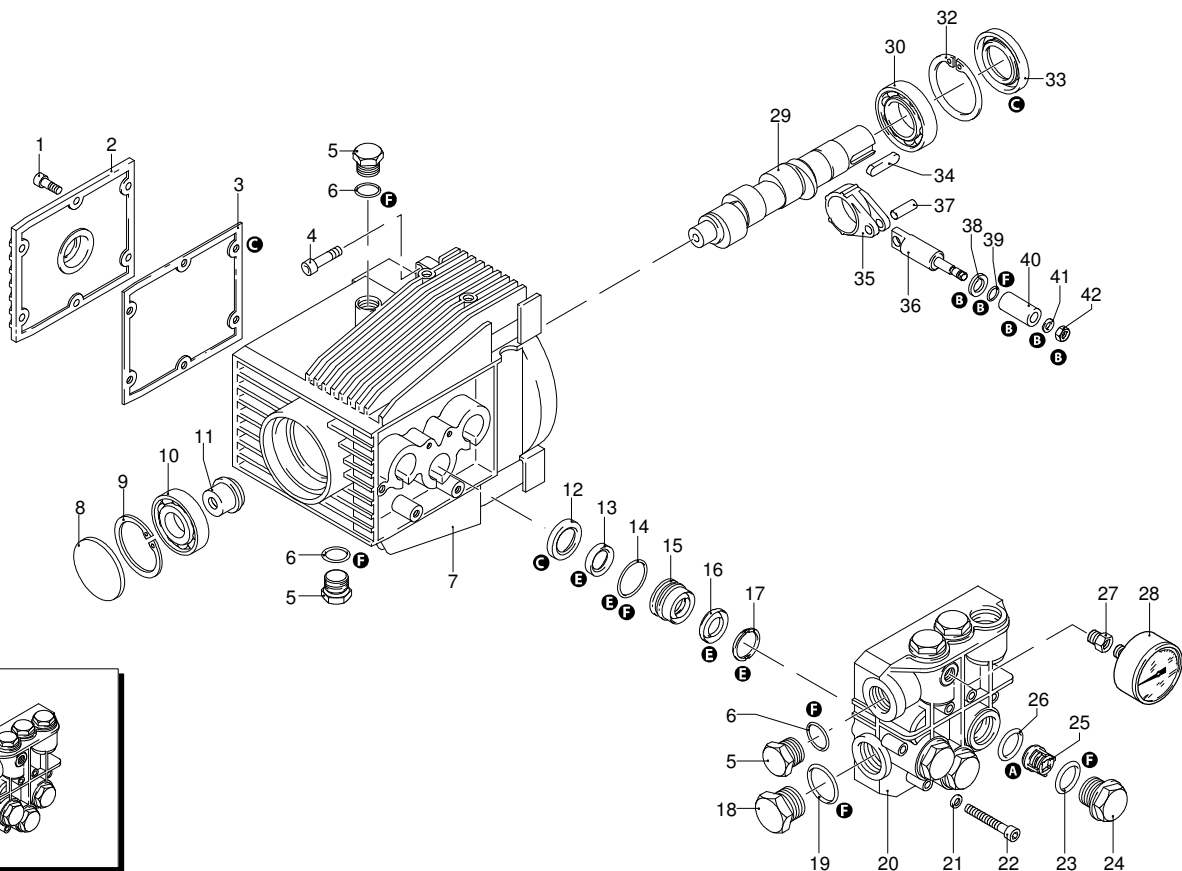
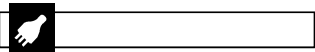
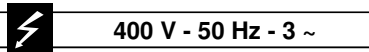



Gültigkeit	Pos.	Code	Bezeichnung	Menge
	1	1260760	Schraube	6
	2	1269101	Deckel	1
	3	1260040	Öldichtung	1
	4	1260780	Schraube	4
	5	1980740	Verschluss	3
	6	740290	O-Ring-Dichtung	3
	7	1260012	Pumpenkörper	1
	8	1266740	Öldichtung	1
	9	1260790	Ring	1
	10	1320370	Lager	1
	11	1320330	Buchse	1
	12	1260460	Öldichtung	3
	13	1260440	Wasserdichtung	3
	14	1260420	O-Ring-Dichtung	3
	15	1260151	Kolbenführung	3
	16	1271650	Wasserdichtung	3
	17	1520120	Ring	3
	18	820361	Verschluss	1
	19	180101	O-Ring-Dichtung	1
	20	1320022	Kopf	1
	21	1381550	Unterlegscheibe	6
	22	680570	Schraube	6
	23	960160	O-Ring-Dichtung	6
	24	1260162	Verschluss	6
	25	1269050	Ventil	6
	26	880830	O-Ring-Dichtung	6
	27	1343160	Verbindungsstück	1
	28	3232	Manometer	1
	29	1260180	Welle	1
	30	180400	Lager	1
	32	1260790	Ring	1
	33	1260750	Öldichtung	1
	34	1380520	Splint	1
	35	1320140	Pleuelstange	3
	36	1260070	Stange	3
	37	1260080	Stecker	3
	38	1260091	Scheibe	3
	39	480480	O-Ring-Dichtung	3
	40	1260121	Kolben	3
	41	1260100	Unterlegscheibe	3
	42	1260110	Mutter	3
	43	1269253	Vormontage Kopf	3
	A	1864	Satz Ventile	1
	B	2628	Satz Kolben	1
	C	1865	Satz Öldichtungen	1
	E	1866	Satz Wasserdichtungen	1
	F	2040	Satz Dichtungen	1

# PROLINER SV 1510 TSS RLW

Ausführung:

Seriennummer:

Code: **12320**

 **400 V - 50 Hz - 3 ~** 

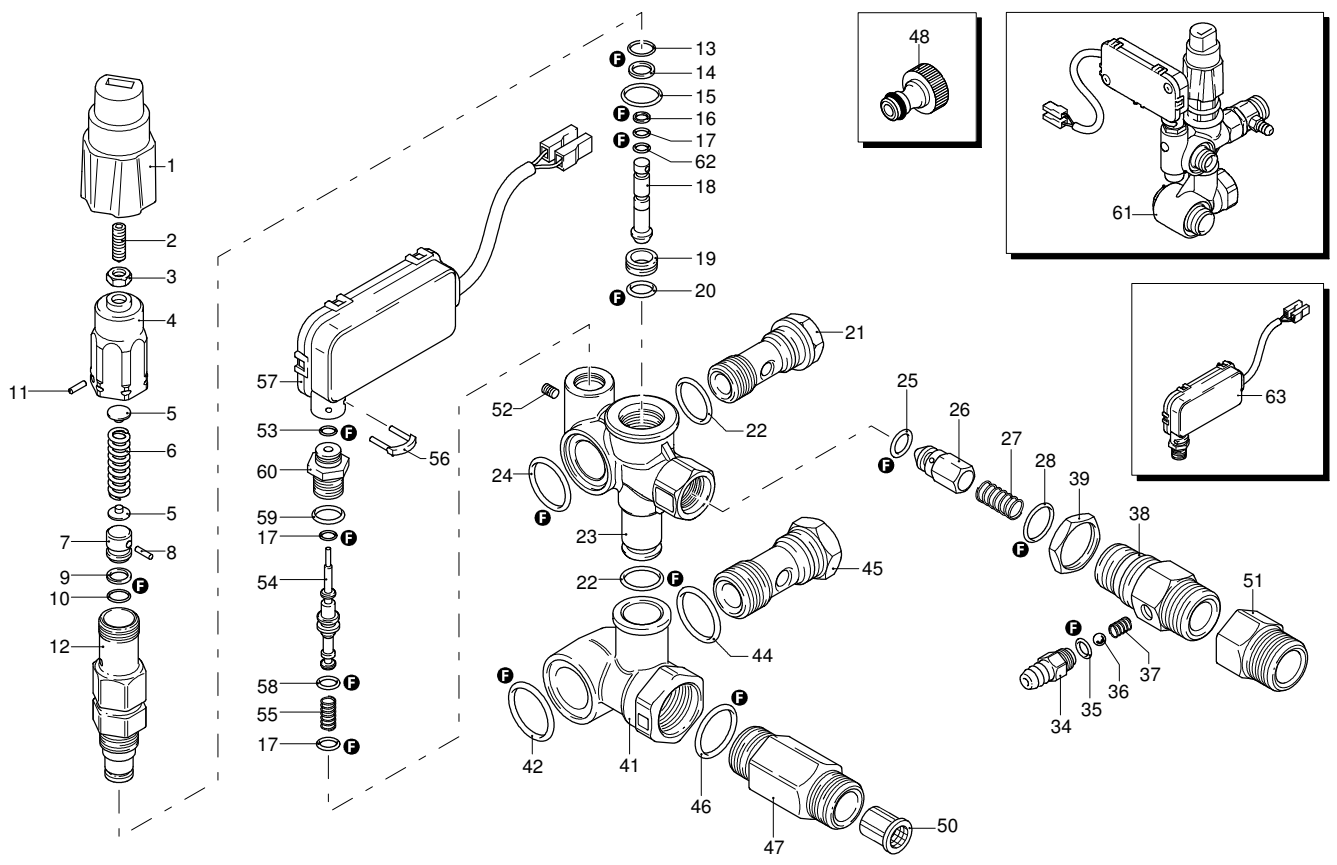

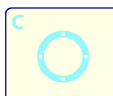

**A** 

**B** 

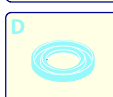
**C** 

**D** 

**E** 

**F** 

**G** 

Gültigkeit	Pos.	Code	Bezeichnung	Menge
	1	2500210	Drehknopf	1
	2	392840	Schraube	1
	3	1980300	Mutter	1
	4	2500540	Einsatz	1
	5	1980220	Teller	2
	6	1271070	Feder	1
	7	1080041	Kolben	1
	8	1080070	Stecker	2
	9	1080401	Ring	1
	10	1080250	O-Ring-Dichtung	1
	11	1080070	Stecker	1
	12	1980210	Kolbenführung	1
	13	740290	O-Ring-Dichtung	1
	14	800560	O-Ring-Dichtung	1
	15	880830	O-Ring-Dichtung	1
	16	1271170	Ring	1
	17	1080192	O-Ring-Dichtung	3
	18	1271160	Kolben	1
	19	1980200	Sitz	1
	20	1470210	O-Ring-Dichtung	1
	21	1540272	Schraube	1
	22	390080	O-Ring-Dichtung	2
	23	1540660	Ventilkörper	1
	24	1140450	O-Ring-Dichtung	1
	25	1460430	O-Ring-Dichtung	1
	26	1540170	Verschluss	1
	27	1080091	Feder	1
	28	394280	O-Ring-Dichtung	1
	34	1560490	Schlauchanschluss	1
	35	480480	O-Ring-Dichtung	1
	36	1250280	Kugel	1
	37	1560520	Feder	1
	38	1540570	Verbindungsstück	1
	39	1540300	Mutter	1
	41	1540280	Ansaugstück	1
	42	1540630	O-Ring-Dichtung	1
	44	880270	O-Ring-Dichtung	1
	45	2260420	Schraube	1
	46	480440	O-Ring-Dichtung	1
	47	1560900	Verbindungsstück	1
	48	1461470	Verbindungsstück	1
	50	1340260	Filter	1
	51	1123960	Verbindungsstück	1
	52	1981190	Schraube	1
	53	1260820	O-Ring-Dichtung	1
	54	1540881	Stange	1
	55	1981320	Feder	1
	56	2022200	Klemme	1
	57	2029753	Vormontage Kasten TSS	1
	58	660191	O-Ring-Dichtung	1
	59	880840	O-Ring-Dichtung	1
	60	1540870	Verbindungsstück	1
	61	22075	Ventil	1
	62	1120681	O-Ring-Dichtung	1
	63	42458	Satz TSS	1
	F	42451	Satz Dichtungen	1

# PROLINER SV 1510 TSS RLW

Ausführung:

Seriennummer:

Code: **12320**

 **400 V - 50 Hz - 3 ~**

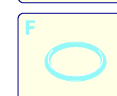
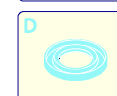
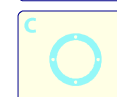
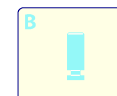
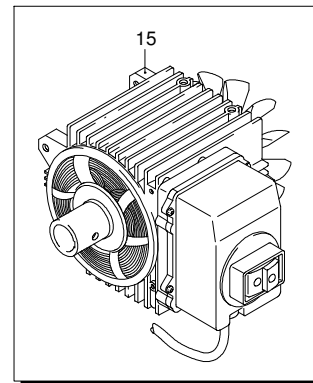
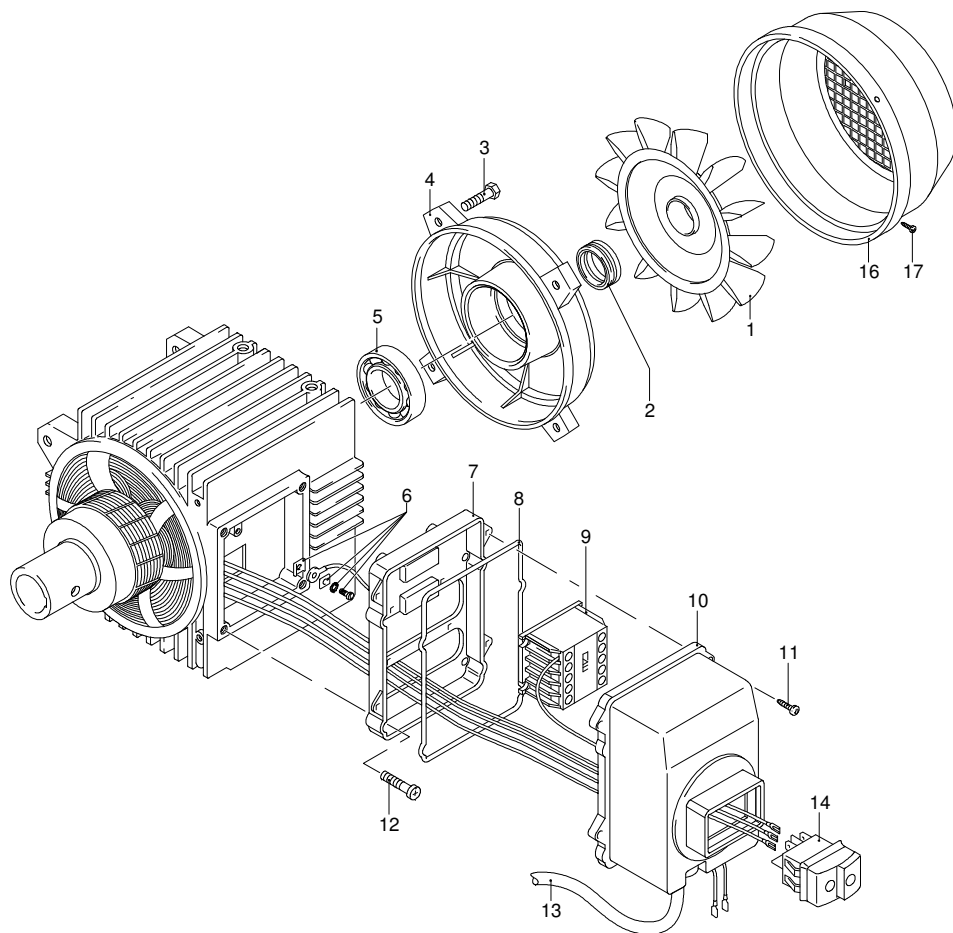

Gültigkeit	Pos.	Code	Bezeichnung	Menge
	1	1260300	Lüfter	1
	2	1260970	Öldichtung	1
	3	480621	Schraube	4
	4	1260961	Schutzschild	1
	5	1260950	Lager	1
	6	1269100	Klemme	1
	7	1981590	Platte	1
	8	2180670	O-Ring-Dichtung	1
	9	1700740	Kleinschütz	1
	10	1981600	Deckel	1
	11	2000210	Schraube	4
	12	1261560	Schraube	4
	13	1270980	Kabel	1
	14	2320280	Schalter	1
	15	44001	Motor	1
	16	1271660	Lüfterdeckel	1
	17	1261570	Schraube	1

# PROLINER SV 1510 TSS RLW

Ausführung:

Seriennummer:

Code: **12320**

 **400 V - 50 Hz - 3 ~**

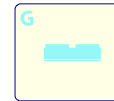
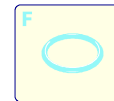
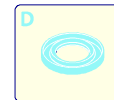
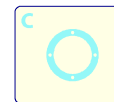
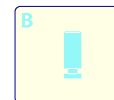
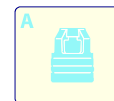
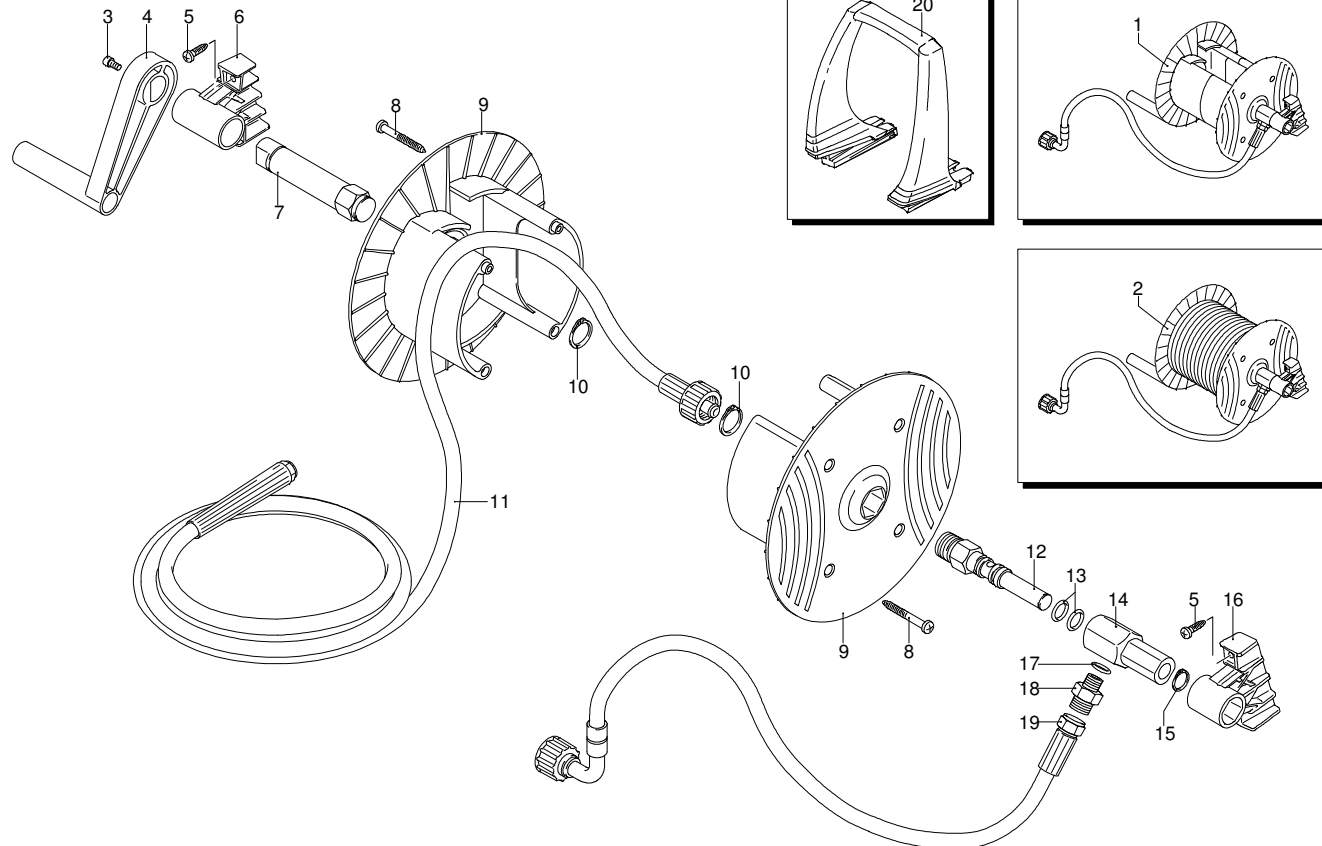

Gültigkeit	Pos.	Code	Bezeichnung	Menge
	1	40644	Vormontage Schlauchhaspel	1
	2	40377	Vormontage Schlauchhaspel	1
	3	2360360	Schraube	1
	4	2360150	Hebel	1
	5	2100300	Schraube	4
	6	2500060	Bügel	1
	7	2500360	Zapfen	1
	8	1681280	Schraube	4
	9	2360230	Scheibe	2
	10	380420	Ring	2
	11	2500390	Hochdruckschlauch	1
	12	2360210	Zapfen	1
	13	390080	O-Ring-Dichtung	2
	14	2360220	Verbindungsstück	1
	15	2360320	Ring	1
	16	2500070	Bügel	1
	17	820510	O-Ring-Dichtung	1
	18	2360310	Verbindungsstück	1
	19	2360250	Hochdruckschlauch	1
	20	2500020	Griff	1

# PROLINER SV 1510 TSS RLW

Ausführung:





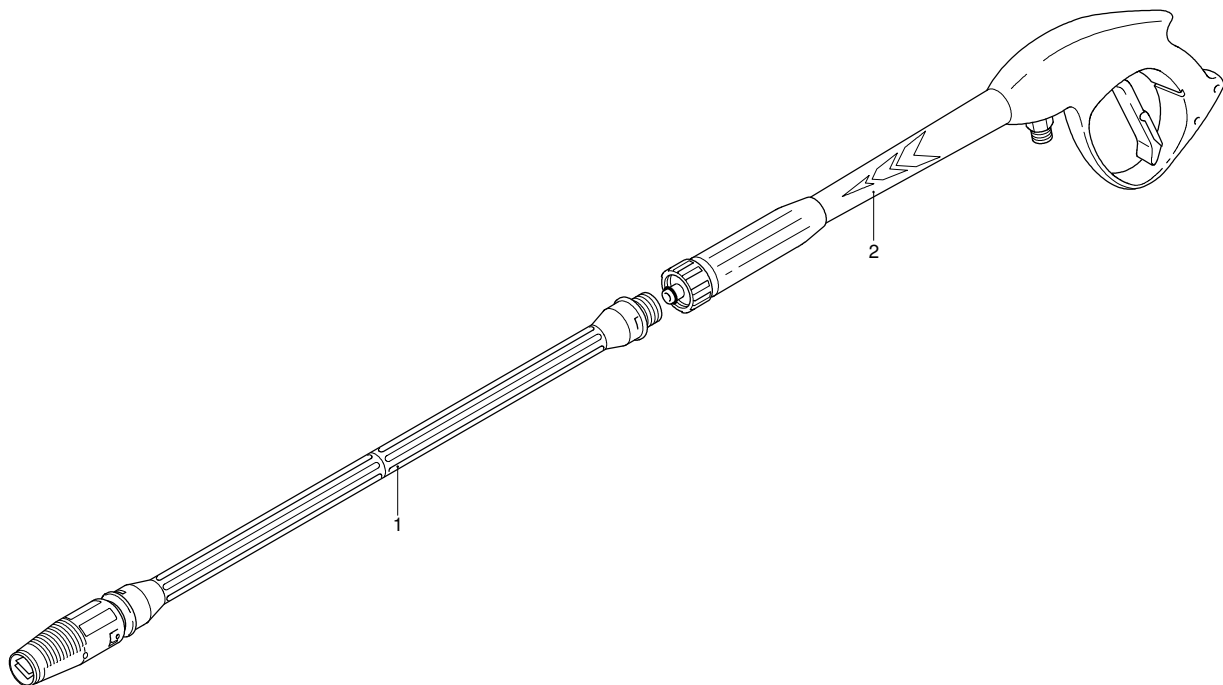

Seriennummer:

Code: **12320**

 400 V - 50 Hz - 3 ~





- A 
- B 
- C 
- D 
- E 
- F 
- G 

Gültigkeit	Pos.	Code	Bezeichnung	Menge
	1	40039	Lanze+Düsenkopf	1
	2	40925	Pistole	1