

# XPRO 9.14 TSS

Ausführung:

Seriennummer:

Code: **13015**

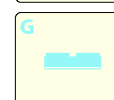
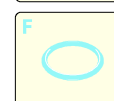
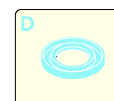
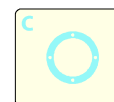
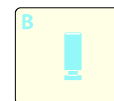
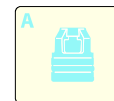
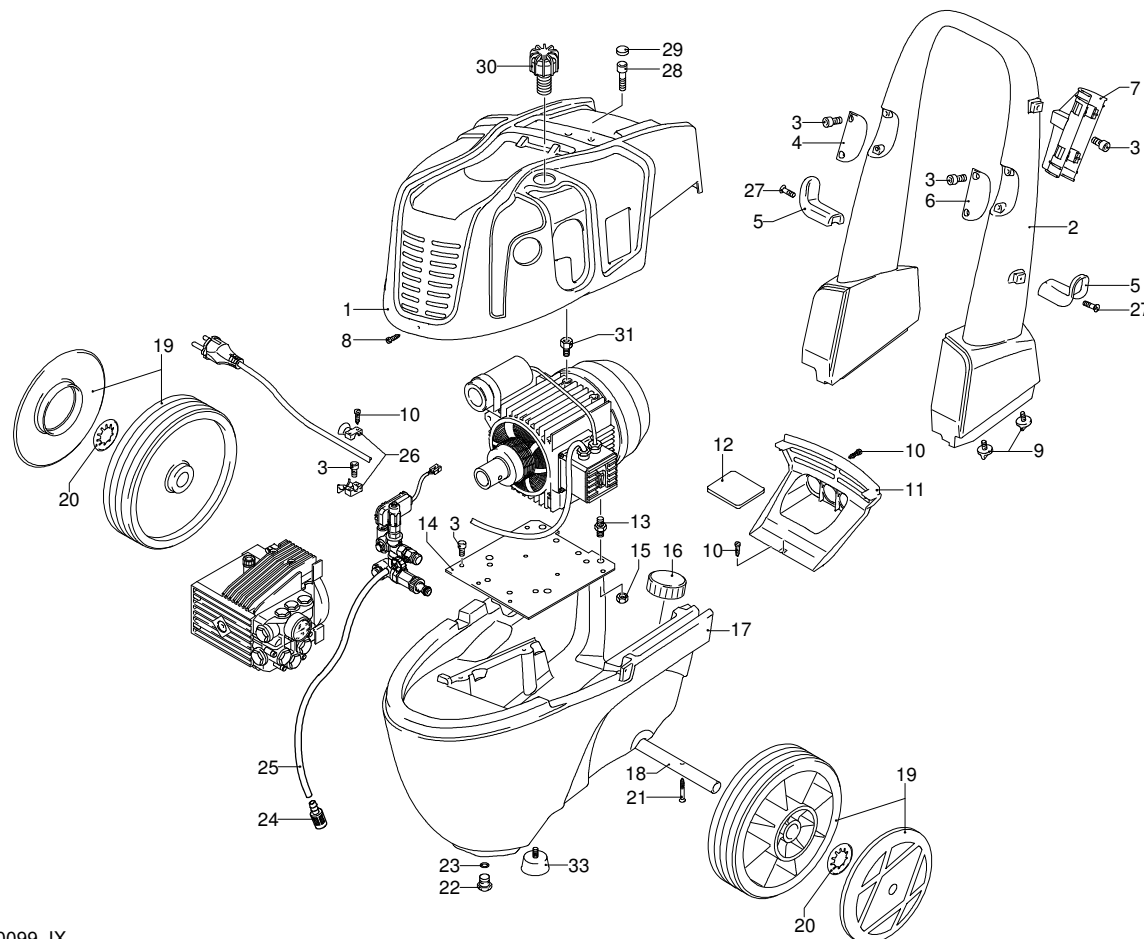
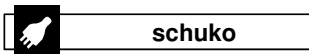
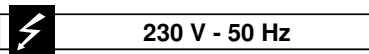

Gültigkeit	Pos.	Code	Bezeichnung	Menge
	1	2360621	Gelbe Haube	1
	2	2360020	Griff	1
	3	2360360	Schraube	9
	4	2360300	Verschluss	1
	5	2360090	Haken	2
	6	2360170	Verschluss	1
	7	2360100	Halterung	1
	8	2100300	Schraube	3
	9	2360270	Knauf	4
	10	2000110	Schraube	4
	11	2360040	Schwarze Haube	1
	12	2360370	Dichtung	1
	13	2360240	Stiftbolzen	4
	14	2360050	Platte	1
	15	380240	Mutter	4
	16	91680930	Verschluss	1
	17	2360010	Basis	1
	18	2360070	Achse	1
	19	1201290	Rad	2
	20	380620	Unterlegscheibe	2
	21	1470220	Schraube	2
	22	1682420	Verschluss	1
	23	2000240	O-Ring-Dichtung	1
	24	2000230	Filter	1
	25	1270960	Reinigungsmittelschlauch	1
	26	2360110	Klemme	1
	27	2100300	Schraube	2
	28	850250	Schraube	2
	29	1270910	Verschluss	2
	30	2360760	Knauf	1
	31	2360660	Stiftbolzen	2
	33	2360780	Schwingungsdämpfer	2

# XPRO 9.14 TSS

Ausführung:

Seriennummer:

Code: **13015**

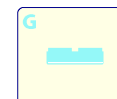
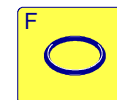
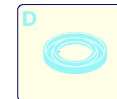
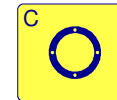
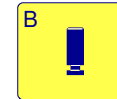
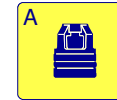
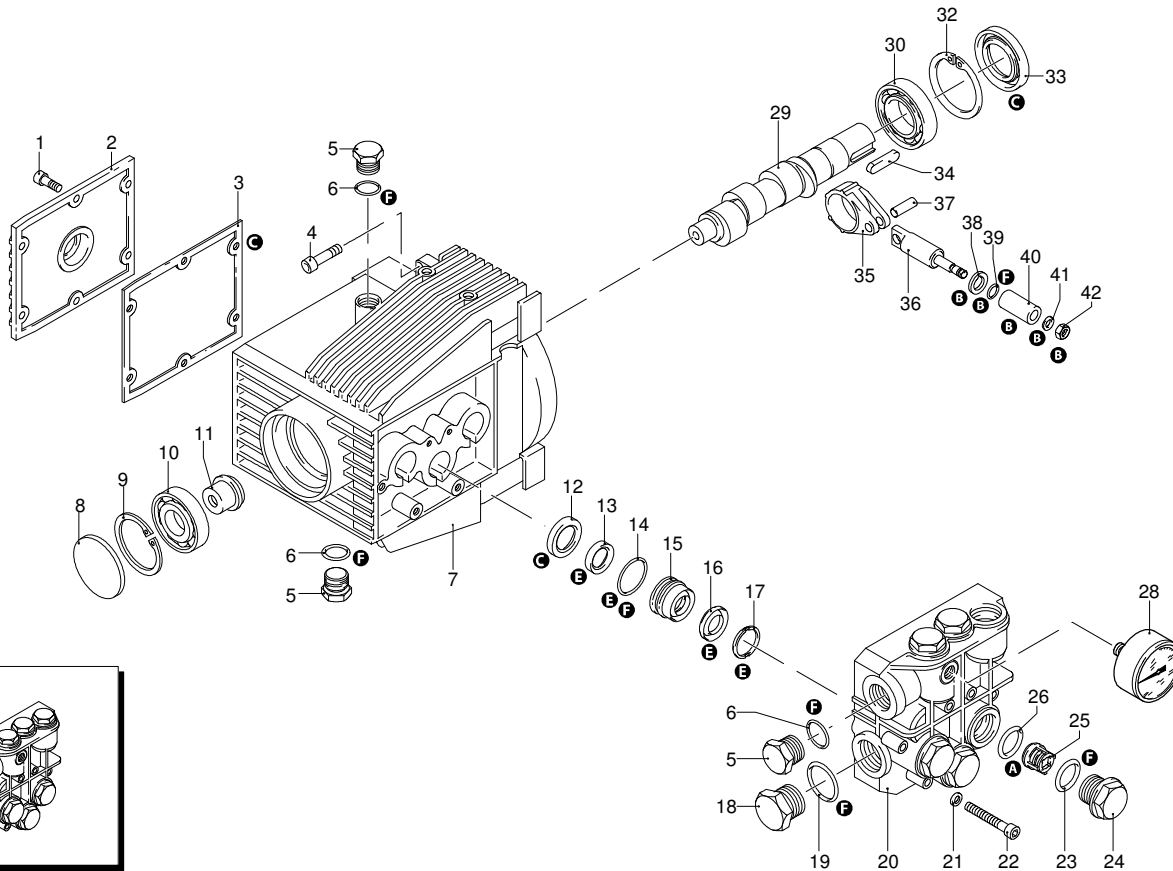
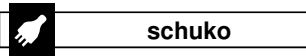
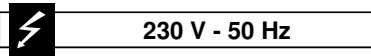

Gültigkeit	Pos.	Code	Bezeichnung	Menge
	1	1260760	Schraube	6
	2	1269101	Deckel	1
	3	1260040	Öldichtung	1
	4	1260780	Schraube	4
	5	1980740	Verschluss	3
	6	740290	O-Ring-Dichtung	3
	7	1260012	Pumpenkörper	1
	8	1266740	Öldichtung	1
	9	1260790	Ring	1
	10	1320370	Lager	1
	11	1320330	Buchse	1
	12	1260460	Öldichtung	3
	13	1260450	Wasserdichtung	3
	14	1260420	O-Ring-Dichtung	3
	15	1320351	Kolbenführung	3
	16	1780720	Wasserdichtung	3
	17	1320340	Ring	3
	18	820361	Verschluss	1
	19	180101	O-Ring-Dichtung	1
	20	1320020	Kopf	1
	21	1381550	Unterlegscheibe	6
	22	680570	Schraube	6
	23	960160	O-Ring-Dichtung	6
	24	1260162	Verschluss	6
	25	1269050	Ventil	6
	26	880830	O-Ring-Dichtung	6
	28	3226	Manometer	1
	29	1322170	Welle	1
	30	180400	Lager	1
	32	1260790	Ring	1
	33	1260750	Öldichtung	1
	34	1380520	Splint	1
	35	1320140	Pleuelstange	3
	36	1260070	Stange	3
	37	1260080	Stecker	3
	38	1260091	Scheibe	3
	39	480480	O-Ring-Dichtung	3
	40	1260211	Kolben	3
	41	1260100	Unterlegscheibe	3
	42	1260110	Mutter	3
	43	1269284	Vormontage Kopf	1
	A	1864	Satz Ventile	1
	B	2629	Satz Kolben	1
	C	1865	Satz Öldichtungen	1
	E	1874	Satz Wasserdichtungen	1
	F	2040	Satz Dichtungen	1

# XPRO 9.14 TSS

Ausführung:

Seriennummer:

Code: **13015**

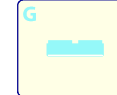
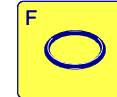
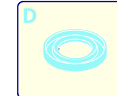
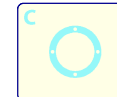
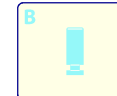
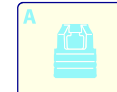
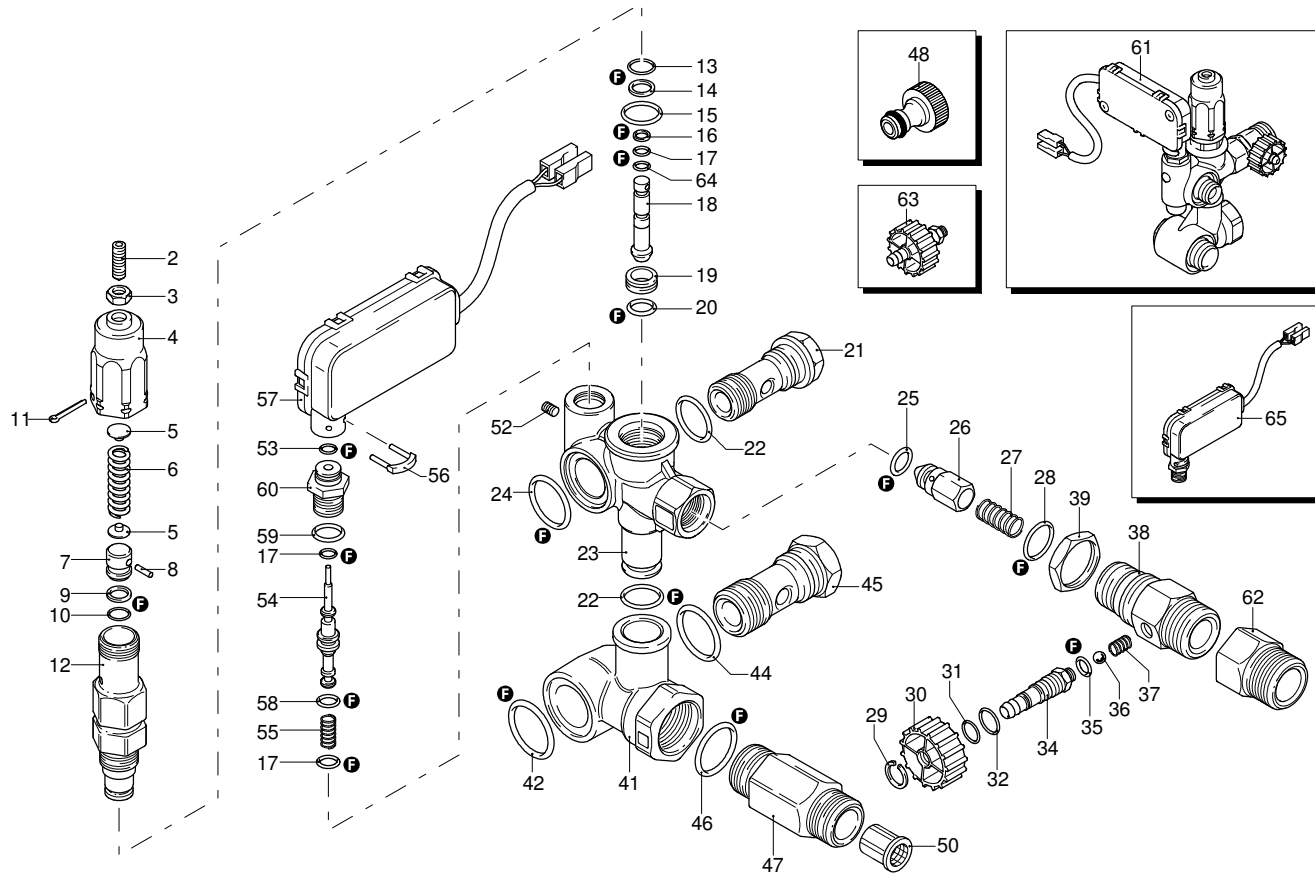
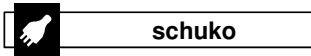
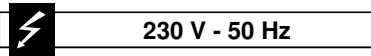

Gültigkeit	Pos.	Code	Bezeichnung	Menge
	2	392840	Schraube	1
	3	1980300	Mutter	1
	4	2500540	Einsatz	1
	5	1980220	Teller	2
	6	1271070	Feder	1
	7	1080041	Kolben	1
	8	1080070	Stecker	1
	9	1080401	Ring	1
	10	1080250	O-Ring-Dichtung	1
	11	2500550	Splintstift	1
	12	1980210	Kolbenführung	1
	13	740290	O-Ring-Dichtung	1
	14	800560	O-Ring-Dichtung	1
	15	880830	O-Ring-Dichtung	1
	16	1271170	Ring	1
	17	1080192	O-Ring-Dichtung	3
	18	1271160	Kolben	1
	19	1980200	Sitz	1
	20	1470210	O-Ring-Dichtung	1
	21	1540272	Schraube	1
	22	390080	O-Ring-Dichtung	2
	23	1540660	Ventilkörper	1
	24	1140450	O-Ring-Dichtung	1
	25	1460430	O-Ring-Dichtung	1
	26	1540170	Verschluss	1
	27	1080091	Feder	1
	28	394280	O-Ring-Dichtung	1
	29	1560660	Ring	1
	30	2360650	Drehknopf	1
	31	480560	O-Ring-Dichtung	1
	32	800560	O-Ring-Dichtung	1
	34	1560650	Schlauchanschluss	1
	35	480480	O-Ring-Dichtung	1
	36	1250280	Kugel	1
	37	1560520	Feder	1
	38	1540570	Verbindungsstück	1
	39	1540300	Mutter	1
	41	1540280	Ansaugstück	1
	42	1540630	O-Ring-Dichtung	1
	44	880270	O-Ring-Dichtung	1
	45	2260420	Schraube	1
	46	480440	O-Ring-Dichtung	1
	47	1560900	Verbindungsstück	1
	48	40393	Verbindungsstück	1
	50	1340260	Filter	1
	52	1981190	Schraube	1
	53	1260820	O-Ring-Dichtung	1
	54	1540881	Stange	1
	55	1981320	Feder	1
	56	2022200	Klemme	1
	57	2029758	Vormontage Kasten TSS	1
	58	660190	O-Ring-Dichtung	1
	59	880840	O-Ring-Dichtung	1
	60	1540870	Verbindungsstück	1
	61	22073	Ventil	1
	62	1123960	Verbindungsstück	1
	63	1569210	Vormontage IDR	1
	64	1120681	O-Ring-Dichtung	1
	65	42458	Satz TSS	1
	F	42451	Satz Dichtungen	1

# XPRO 9.14 TSS

Ausführung:

Seriennummer:

Code: **13015**

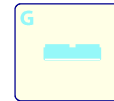
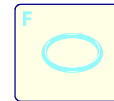
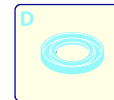
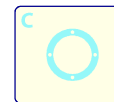
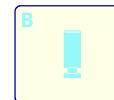
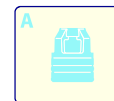
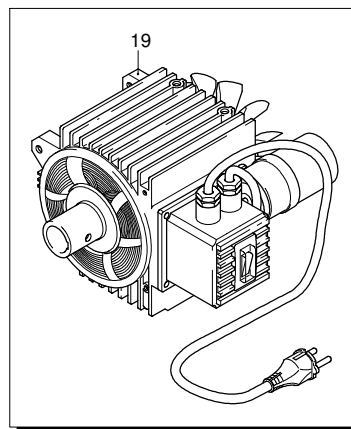
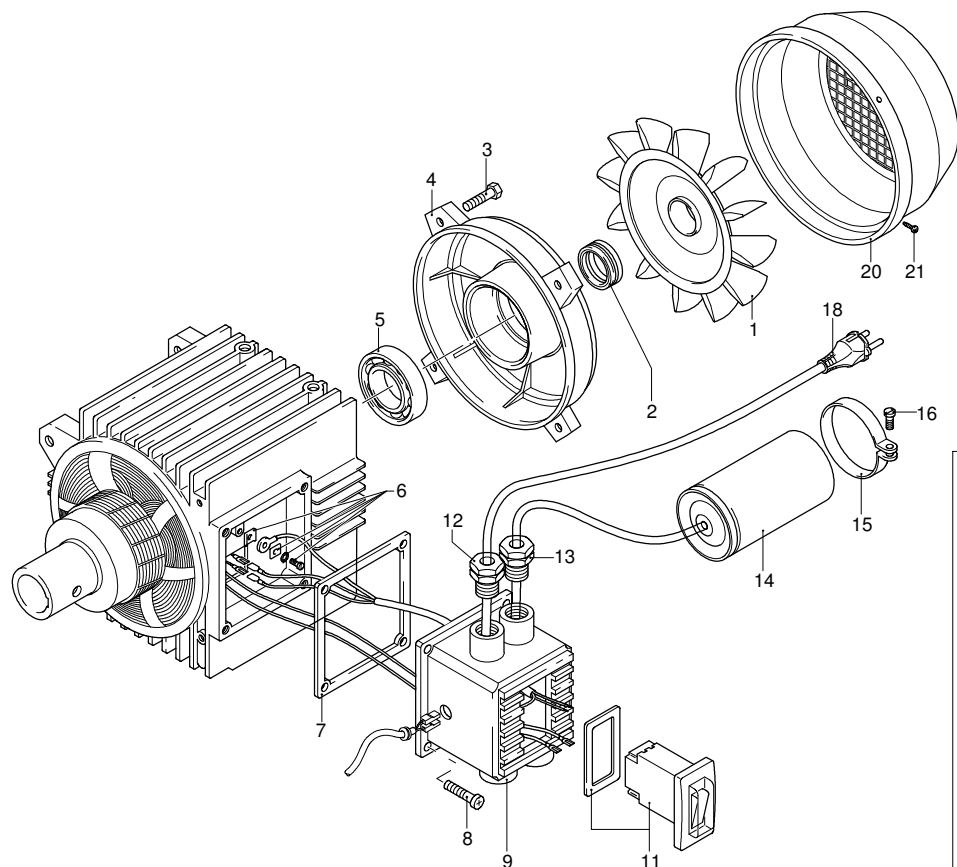
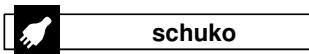
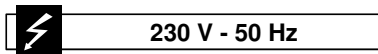

Gültigkeit	Pos.	Code	Bezeichnung	Menge
	1	1260300	Lüfter	1
	2	1260970	Öldichtung	1
	3	480621	Schraube	4
	4	1260961	Schutzschild	1
	5	1260950	Lager	1
	6	1269100	Klemme	1
	7	1260400	Dichtung	1
	8	1261560	Schraube	4
	9	1272010	Kasten	1
	11	1272370	Schalter	1
	12	1271950	Kabelhalterung	1
	13	1269090	Kabelhalterung	1
	14	2360400	Kondensator	1
	15	2360330	Schelle	1
	16	1271880	Schraube	1
	18	1270950	Kabel	1
	19	4553	Motor	1
	20	1271660	Lüfterdeckel	1
	21	1261570	Schraube	4



**ANNOVI  
REVERBERI**  
The Power of Experience

05/05/2011

# XPRO 9.14 TSS

Ausführung:

Seriennummer:

Code: **13015**

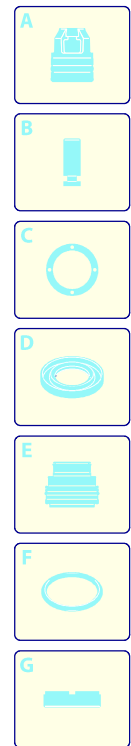
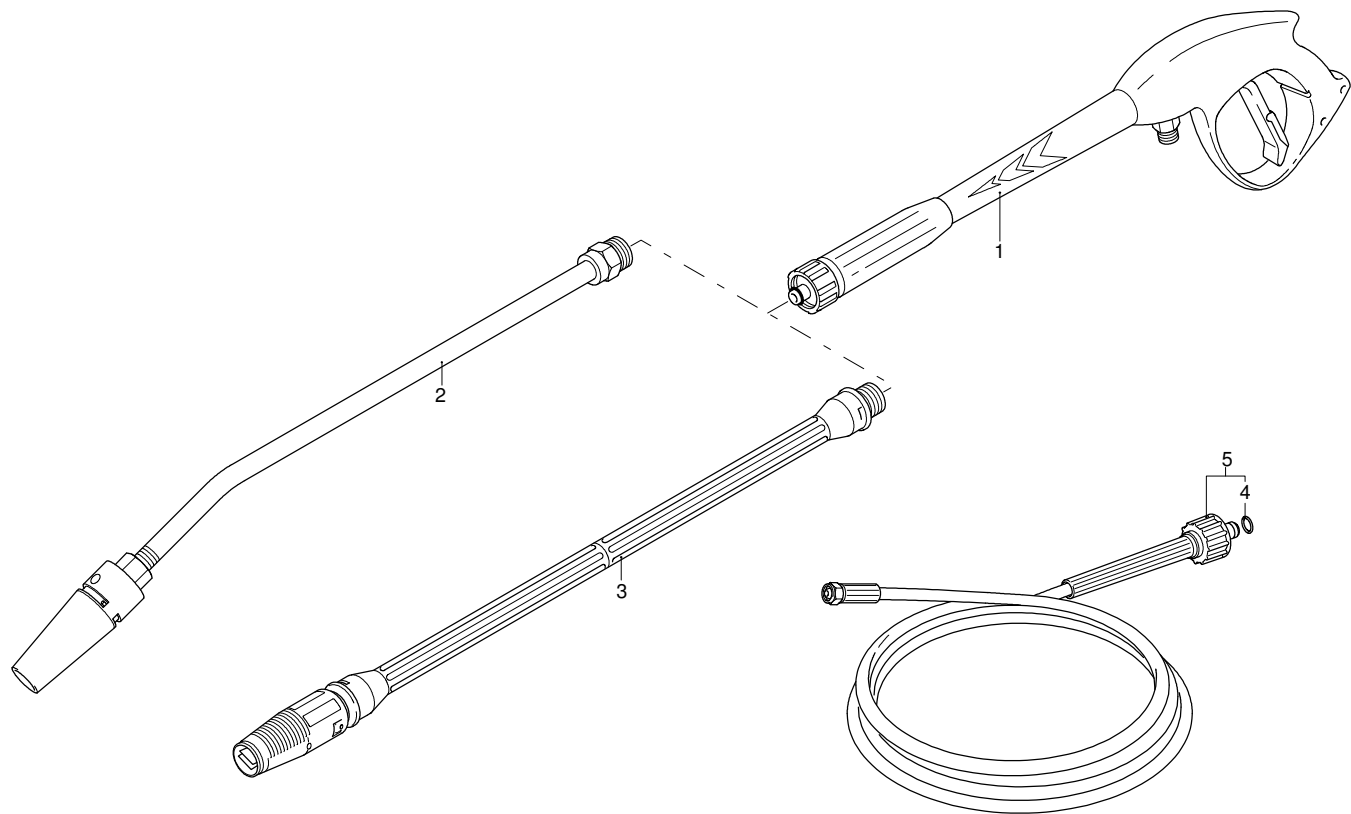
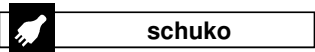
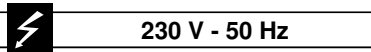

Gültigkeit	Pos.	Code	Bezeichnung	Menge
	1	40925	Pistole	1
I---> 01-10	2	40713	Lanze+Düsenkopf	1
--->I 12-09	3	40114	Lanze+Düsenkopf	1
	4	2000770	O-Ring-Dichtung	1
	5	1271960	Hochdruckschlauch	1

UN\_CE\_0321-HW