



# XPRO SK 21.15 TSS RLW

Ausführung:

Seriennummer:

Code: **22608**

 **400 V - 50 Hz - 3 ~**



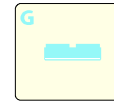
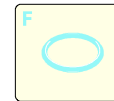
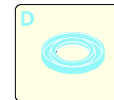
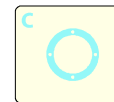
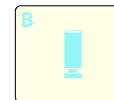
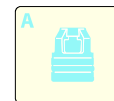
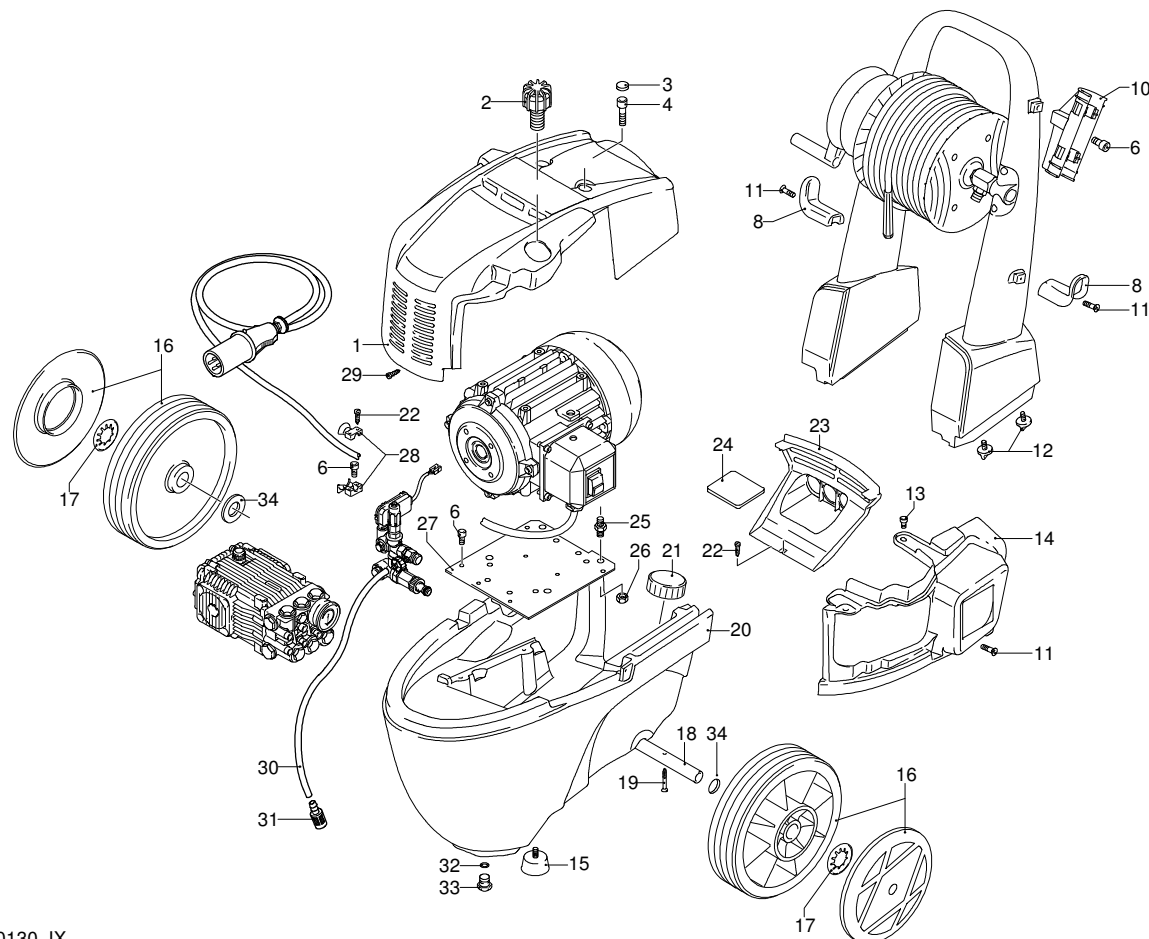

Gültigkeit	Pos.	Code	Bezeichnung	Menge
	1	2360541	Gelbe Haube	1
	2	2360760	Knauf	1
	3	1270910	Verschluss	2
	4	850250	Schraube	2
	6	2360360	Schraube	7
	8	2360090	Haken	2
	10	2360100	Halterung	1
	11	2100300	Schraube	3
	12	2360720	Knauf	4
	13	850250	Schraube	2
	14	2360551	Gelbe Haube	1
	15	2360780	Schwingungsdämpfer	2
	16	2360570	Rad	2
	17	380620	Unterlegscheibe	2
	18	2360560	Achse	1
	19	1470220	Schraube	2
	20	2360010	Basis	1
	21	91680930	Verschluss	1
	22	2000110	Schraube	3
	23	2360040	Schwarze Haube	1
	24	2360370	Dichtung	1
	25	2360580	Stiftbolzen	4
	26	380240	Mutter	4
	27	2360052	Platte	1
	28	2360110	Klemme	1
	29	2360710	Schraube	1
	30	1270960	Reinigungsmittelschlauch	1
	31	2000230	Filter	1
	32	2000240	O-Ring-Dichtung	1
	33	1682420	Verschluss	1
	34	380570	Unterlegscheibe	2

# XPRO SK 21.15 TSS RLW

Ausführung:

Seriennummer:

Code: **22608**

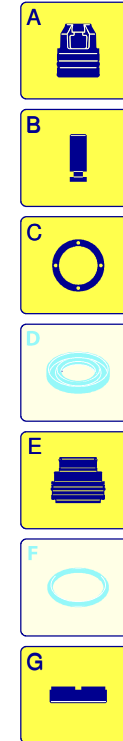
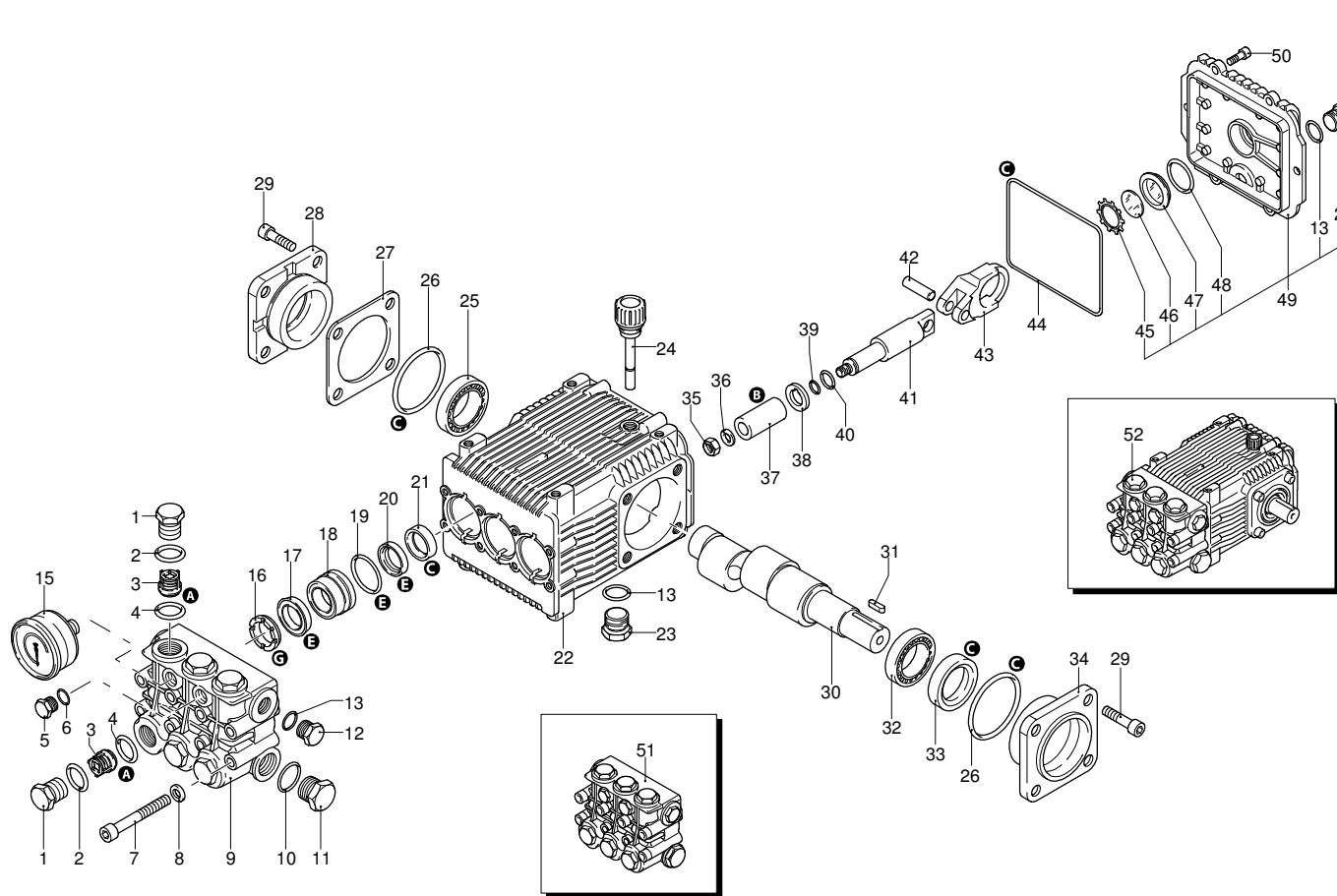
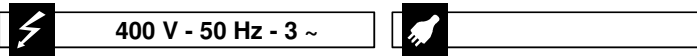

Gültigkeit	Pos.	Code	Bezeichnung	Menge
	1	960090	Verschluss	6
	2	960160	O-Ring-Dichtung	6
	3	1389051	Ventil	6
	4	880830	O-Ring-Dichtung	6
	5	880581	Verschluss	2
	6	820510	O-Ring-Dichtung	2
	7	820150	Schraube	8
	8	1381850	Unterlegscheibe	8
	9	1380020	Kopf	1
	10	180101	O-Ring-Dichtung	1
	11	820361	Verschluss	1
	12	1980740	Verschluss	1
	13	740290	O-Ring-Dichtung	3
	15	1381580	Manometer	1
	16	840320	Ring	3
	17	840330	Wasserdichtung	3
	18	1380160	Kolbenführung	3
	19	961240	O-Ring-Dichtung	3
	20	840340	Wasserdichtung	3
	21	1383130	Öldichtung	3
	22	1382770	Pumpenkörper	1
	23	1980740	Verschluss	2
	24	880130	Verschluss	1
	25	2280240	Lager	1
	26	640030	O-Ring-Dichtung	2
	27	1380120	Zwischenstück 0,10 mm	1
	27	1380130	Zwischenstück 0,20 mm	1
	27	1380530	Zwischenstück 0,25 mm	1
	27	1382810	Zwischenstück 0,05 mm	1
	28	1380050	Halterung	1
	29	850370	Schraube	8
	30	2280080	Welle	1
	31	1380520	Splint	1
	32	840370	Lager	1
	33	180340	Dichtung	1
	34	1380040	Halterung	1
	35	962010	Mutter	3
	36	962000	Unterlegscheibe	3
	37	1382360	Kolben	3
	38	1380950	Scheibe	3
	39	600180	O-Ring-Dichtung	3
	40	1080401	Ring	3
	41	1380920	Stange	3
	42	1380060	Stecker	3
	43	1383050	Pleuelstange	3
	44	1780510	O-Ring-Dichtung	1
	45	1260430	Ring	1
	46	1780690	Scheibe	1
	47	1260250	Füllstandanzeige	1
	48	1140450	O-Ring-Dichtung	1
	49	1789010	Deckel	1
	50	1343510	Schraube	6
	51	1389216	Vormontage Kopf	1
	52	20924	Pumpe	1
	A	2864	Satz Ventile	1
	B	2759	Satz Kolben	1
	C	1855	Satz Öldichtungen	1
	E	1888	Satz Wasserdichtungen	1
	G	1816	Satz Stützringe	1

# XPRO SK 21.15 TSS RLW

Ausführung:

Seriennummer:

Code: **22608**

 **400 V - 50 Hz - 3 ~**

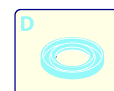
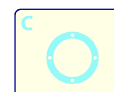
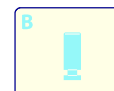
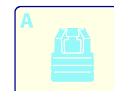
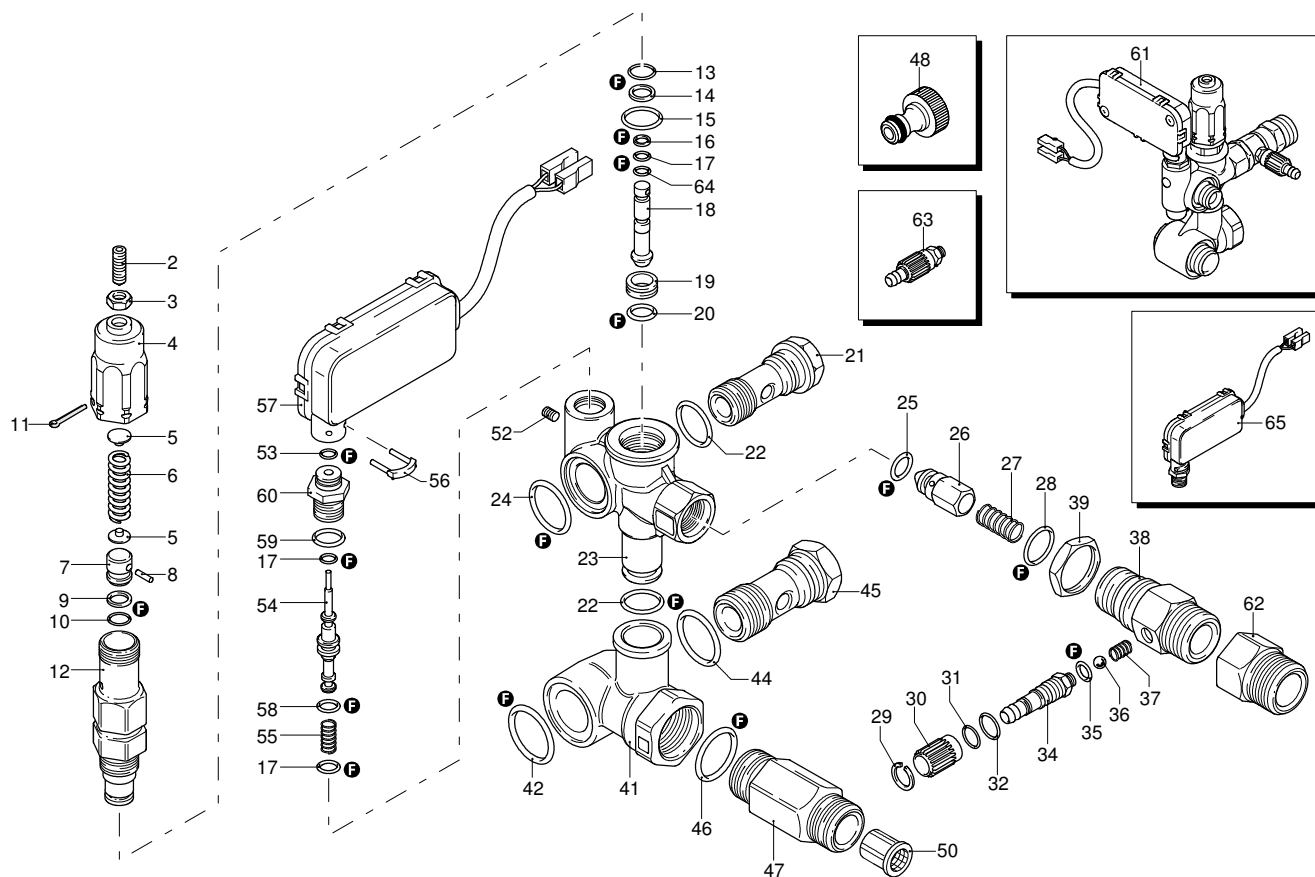
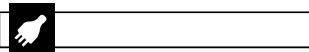

Gültigkeit	Pos.	Code	Bezeichnung	Menge
	2	392840	Schraube	1
	3	1980300	Mutter	1
	4	2500540	Einsatz	1
	5	1980220	Teller	2
	6	1271070	Feder	1
	7	1080041	Kolben	1
	8	1080070	Stecker	1
	9	1080401	Ring	1
	10	1080250	O-Ring-Dichtung	1
	11	2500550	Splintstift	1
	12	1980210	Kolbenführung	1
	13	740290	O-Ring-Dichtung	1
	14	800560	O-Ring-Dichtung	1
	15	880830	O-Ring-Dichtung	1
	16	1271170	Ring	1
	17	1080192	O-Ring-Dichtung	3
	18	1271160	Kolben	1
	19	2460420	Sitz	1
	20	1080250	O-Ring-Dichtung	1
	21	1540272	Schraube	1
	22	390080	O-Ring-Dichtung	2
	23	1540660	Ventilkörper	1
	24	1140450	O-Ring-Dichtung	1
	25	1460430	O-Ring-Dichtung	1
	26	1540170	Verschluss	1
	27	1080091	Feder	1
	28	394280	O-Ring-Dichtung	1
	29	1560660	Ring	1
	30	1560680	Drehknopf	1
	31	480560	O-Ring-Dichtung	1
	32	800560	O-Ring-Dichtung	1
	34	1560650	Schlauchanschluss	1
	35	480480	O-Ring-Dichtung	1
	36	1250280	Kugel	1
	37	1560520	Feder	1
	38	2360770	Verbindungsstück	1
	39	1540300	Mutter	1
	41	1540280	Ansaugstück	1
	42	1540630	O-Ring-Dichtung	1
	44	880270	O-Ring-Dichtung	1
	45	2260420	Schraube	1
	46	480440	O-Ring-Dichtung	1
	47	1560900	Verbindungsstück	1
	48	40393	Verbindungsstück	1
	50	1340260	Filter	1
	52	1981190	Schraube	1
	53	1260820	O-Ring-Dichtung	1
	54	1540881	Stange	1
	55	1981320	Feder	1
	56	2022200	Klemme	1
	57	2029758	Vormontage Kasten TSS	1
	58	660190	O-Ring-Dichtung	1
	59	880840	O-Ring-Dichtung	1
	60	1540870	Verbindungsstück	1
	61	22873	Ventil	1
	62	1123960	Verbindungsstück	1
	63	1569206	Vormontage IDR	1
	64	1120681	O-Ring-Dichtung	1
	65	42458	Satz TSS	1
	F	42451	Satz Dichtungen	1

# XPRO SK 21.15 TSS RLW

Ausführung:

Seriennummer:

Code: **22608**

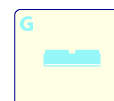
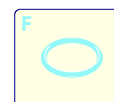
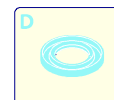
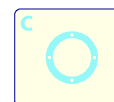
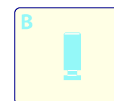
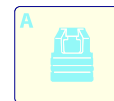
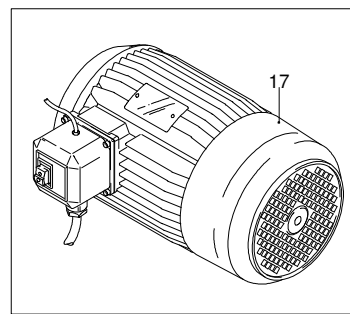
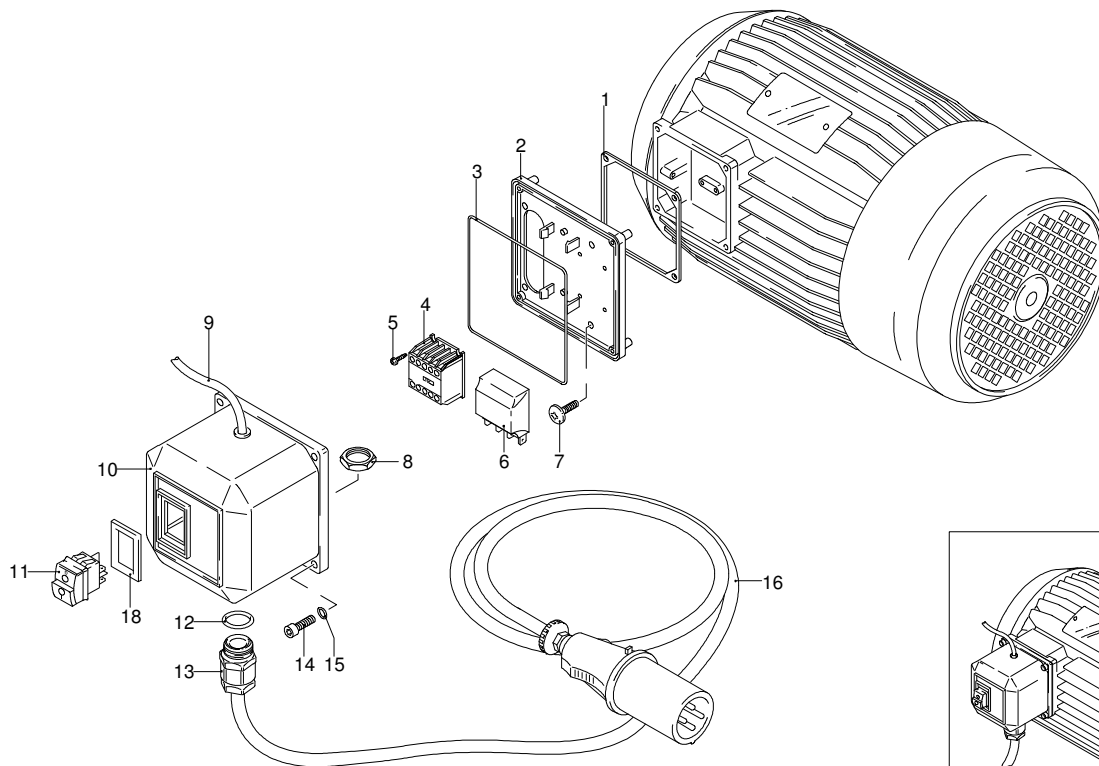
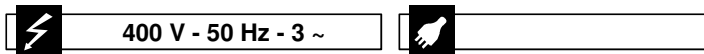

Gültigkeit	Pos.	Code	Bezeichnung	Menge
	1	1700100	Dichtung	1
	2	1700080	Platte	1
	3	1940410	O-Ring-Dichtung	1
	4	1700960	Kleinschütz	1
	5	1261570	Schraube	4
	6	2360590	Karte	1
	7	1460460	Schraube	4
	8	1700590	Mutter	1
	9	2021560	Kabel	1
	10	1700930	Deckel	1
	11	2360730	Schalter	1
	12	880270	O-Ring-Dichtung	1
	13	1382380	Kabelverschraubung	1
	14	1261560	Schraube	4
	15	1080190	O-Ring-Dichtung	4
	16	1700640	Kabel	1
	17	44038	Motor	1
	18	1341140	Dichtung	1

# XPRO SK 21.15 TSS RLW

Ausführung:   
 Seriennummer:   
 Code: **22608**

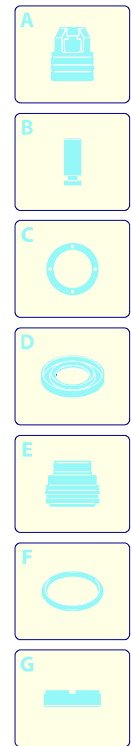
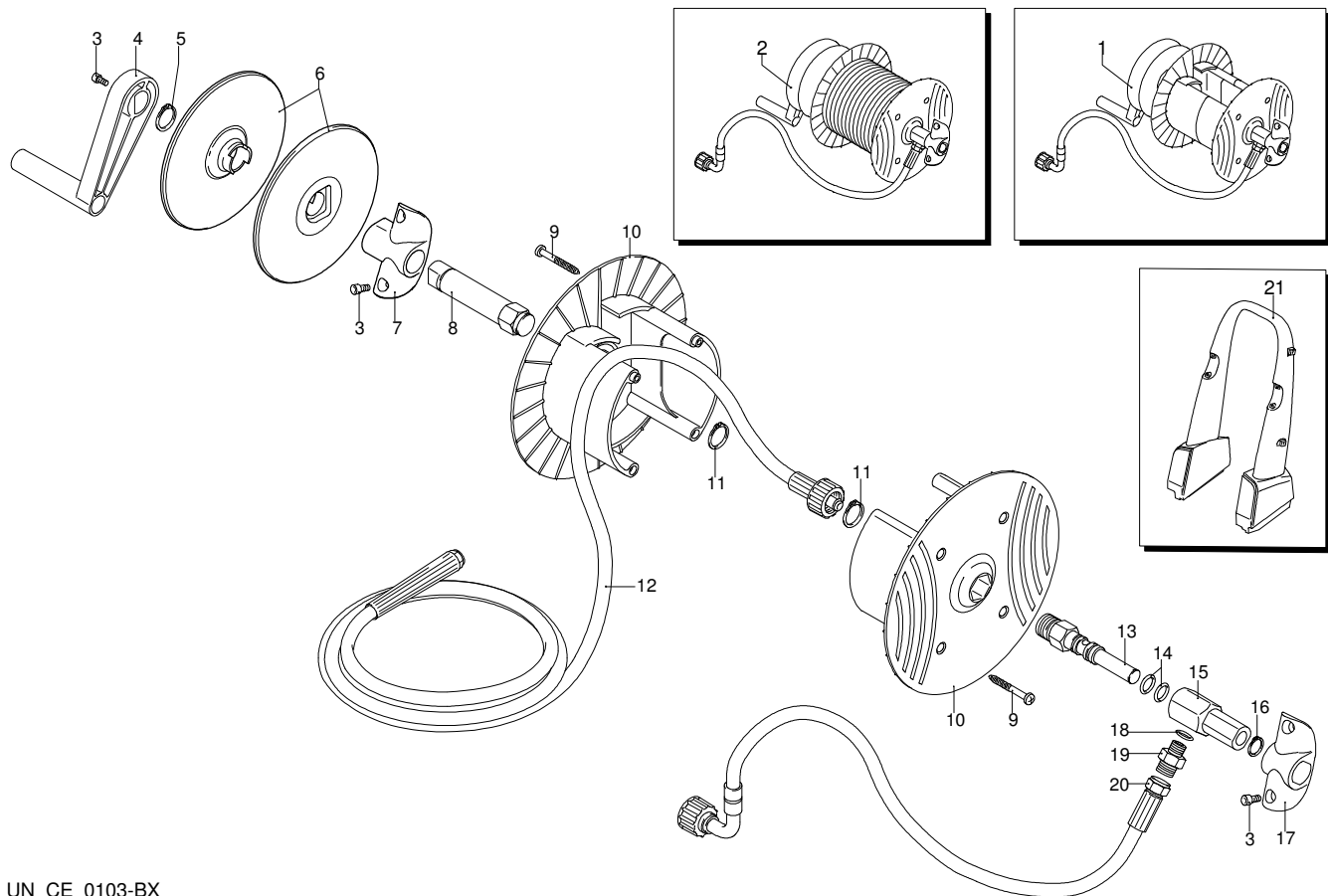
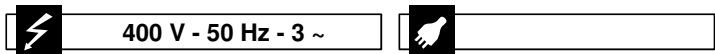

Gültigkeit	Pos.	Code	Bezeichnung	Menge
	1	40646	Vormontage Schlauchhaspel	1
	2	40681	Vormontage Schlauchhaspel	1
	3	2360360	Schraube	1
	4	2360150	Hebel	2
	5	650500	Ring	1
	6	2360190	Scheibe	1
	7	2360160	Bügel	1
	8	2360280	Zapfen	1
	9	1681280	Schraube	4
	10	2360230	Scheibe	2
	11	380420	Ring	2
	12	2360260	Hochdruckschlauch	1
	13	2360210	Zapfen	1
	14	390080	O-Ring-Dichtung	2
	15	2360220	Verbindungsstück	1
	16	2360320	Ring	1
	17	2360080	Bügel	1
	18	820510	O-Ring-Dichtung	1
	19	2360310	Verbindungsstück	1
	20	2360250	Hochdruckschlauch	1
	21	2360020	Griff	1

# XPRO SK 21.15 TSS RLW

Ausführung:

Seriennummer:

Code: **22608**

 400 V - 50 Hz - 3 ~



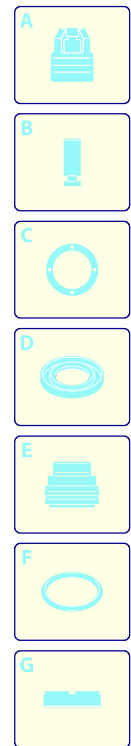
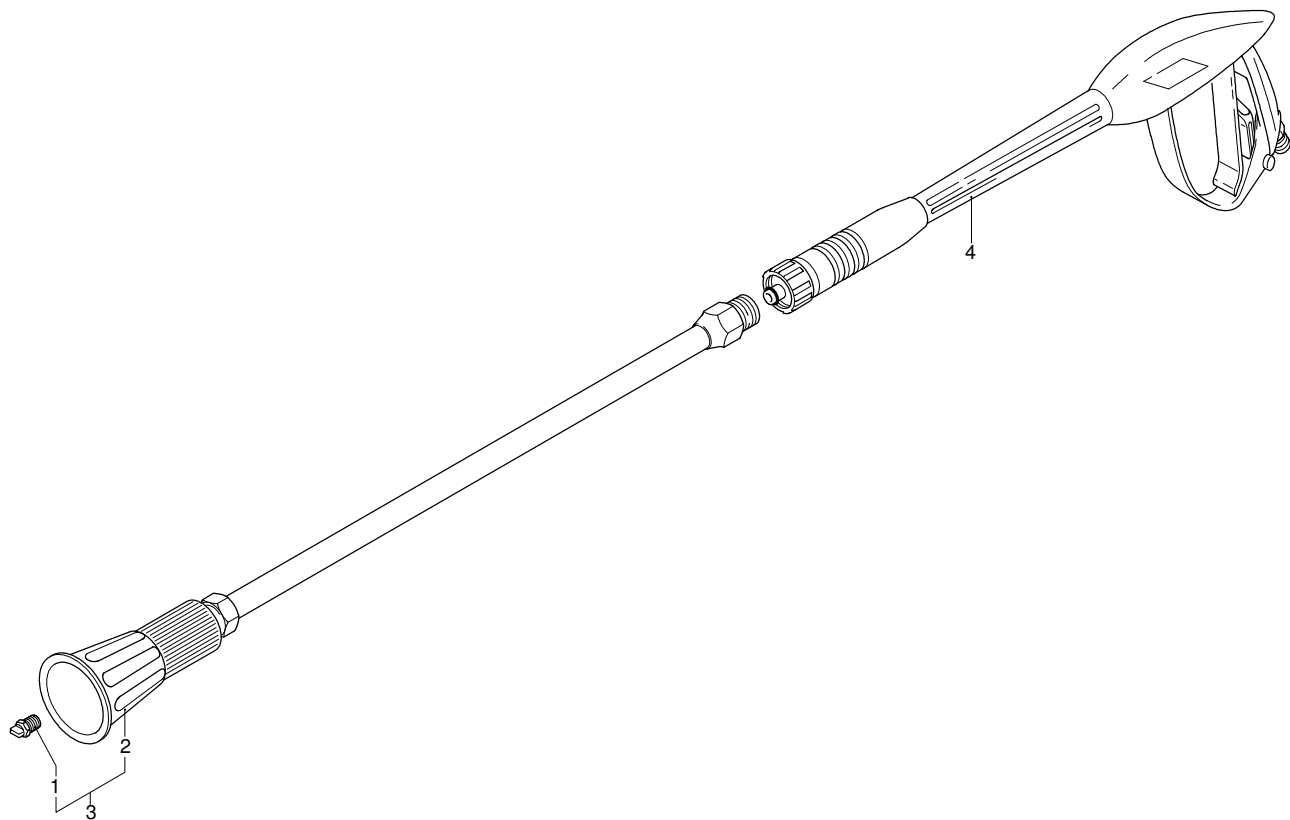

Gültigkeit	Pos.	Code	Bezeichnung	Menge
	1	3157	Düse	1
	2	40541	Lanze+Düsenkopf ohne Düse	1
	3	40708	Lanze+Düsenkopf	1
	4	41045	Pistole	1