



Modell PW 1700 W

Ausführung: PW 1700 W 2 SPEED

Seriennummer: _____

Code: 12212

01/02/2010

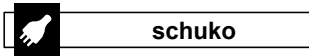
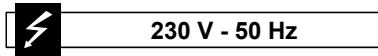

Gültigkeit	Pos.	Code	Bezeichnung	Menge
	1	2560380	Drehknopf	1
	2	2560490	Stecker	1
	3	2860015	Orangefarbene Haube	1
	4	2440071	Rad	2
	5	2100300	Schraube	16
	6	2860030	Schwarze Haube	1
	7	2860020	Schwarze Haube	1

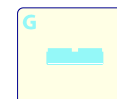
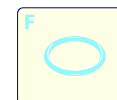
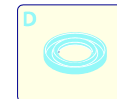
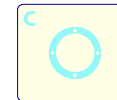
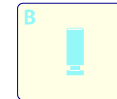
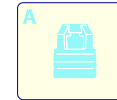
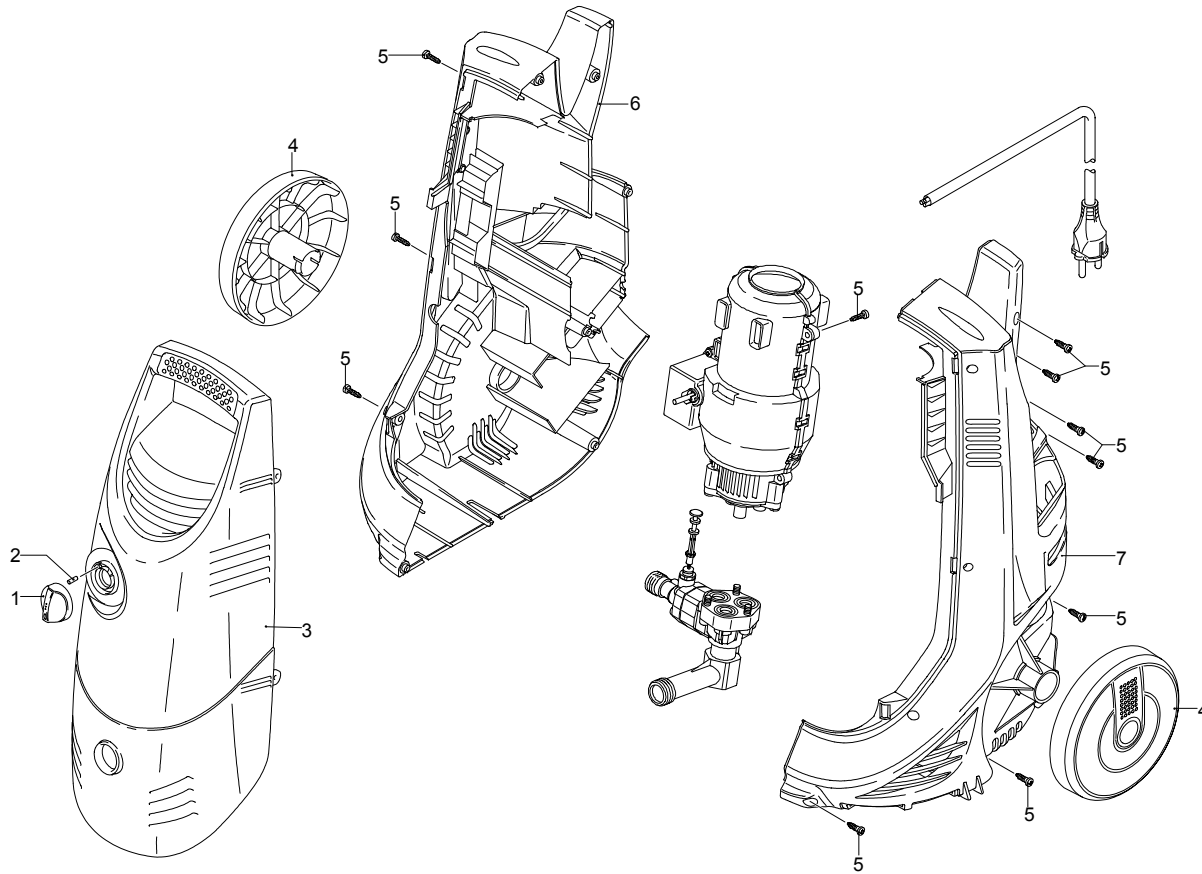

UN_CE_0345-AW



01/02/2010

Modell PW 1700 W

Ausführung: PW 1700 W 2 SPEED

Seriennummer: _____

Code: 12212

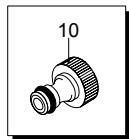
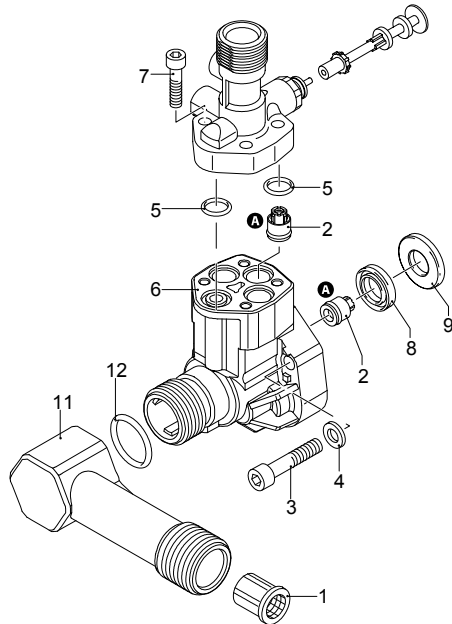
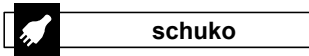
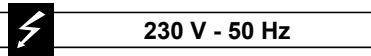

UN_CE_0372-AW

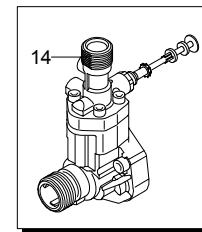
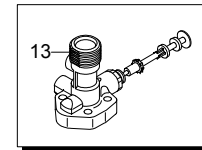
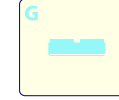
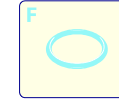
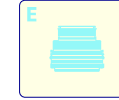
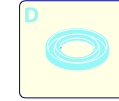
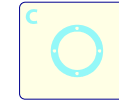
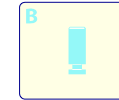
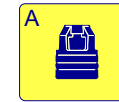

Gültigkeit	Pos.	Code	Bezeichnung	Menge
	1	1340260	Filter	1
	2	2109050	Ventil	6
	3	850850	Schraube	3
	4	2560690	Unterlegscheibe	3
	5	880840	O-Ring-Dichtung	4
	6	2560450	Kopf	1
	7	2560720	Schraube	4
	8	2101120	Wasserdichtung	3
	9	2020041	Ring	3
	10	1461470	Verbindungsstück	1
	11	2560700	Verbindungsstück	1
	12	2440230	Dichtung	1
	13	42012	Vormontage Verbindungsstück	1
	14	2208	Vormontage Kopf	1
	A	2574	Satz Ventile	1



Modell PW 1700 W

Ausführung: **PW 1700 W 2 SPEED**

Seriennummer: _____

Code: **12212**

01/02/2010

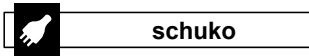
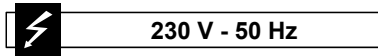

Gültigkeit	Pos.	Code	Bezeichnung	Menge
	1	2560350	Deckel	1
	2	2560130	Leitblech	1
	3	2560400	Schalter	1
	4	2560120	Leitblech	1
	5	2100300	Schraube	2
	6	2560180	Kabel	1
	7	2569559	Vormontage Elektropumpe	1
	8	2260	Bürstesatz für Motor	1

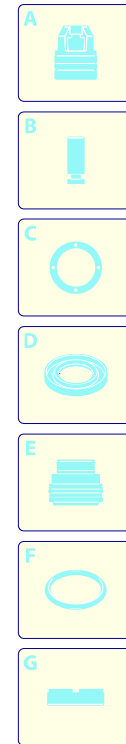
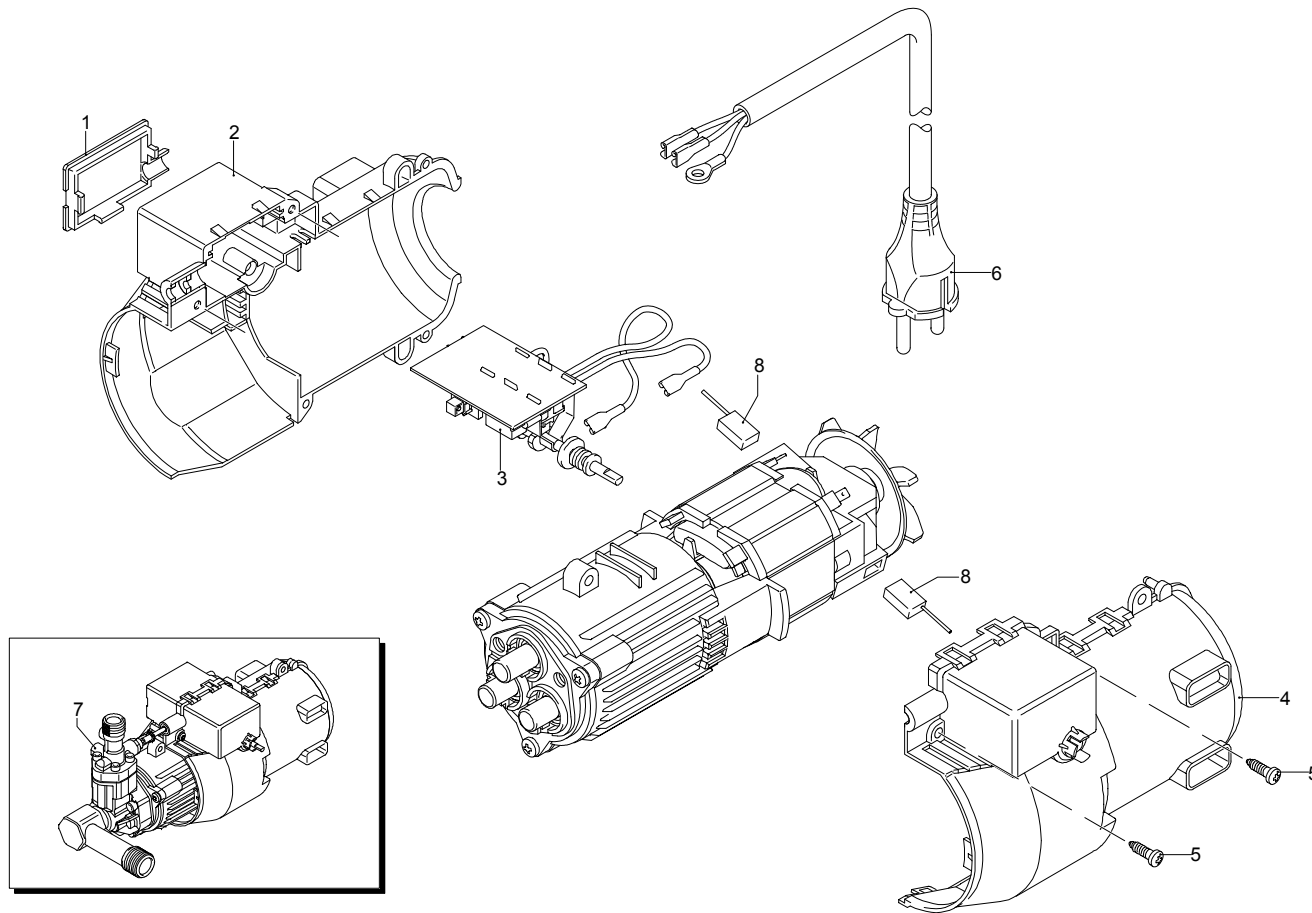

UN_CE_0142-KX



01/02/2010

Modell PW 1700 W

Ausführung: **PW 1700 W 2 SPEED**

Seriennummer:

Code: **12212**

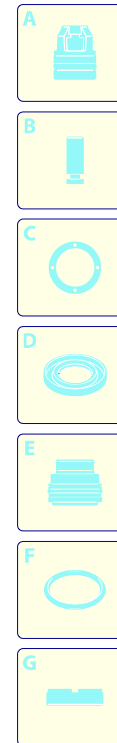
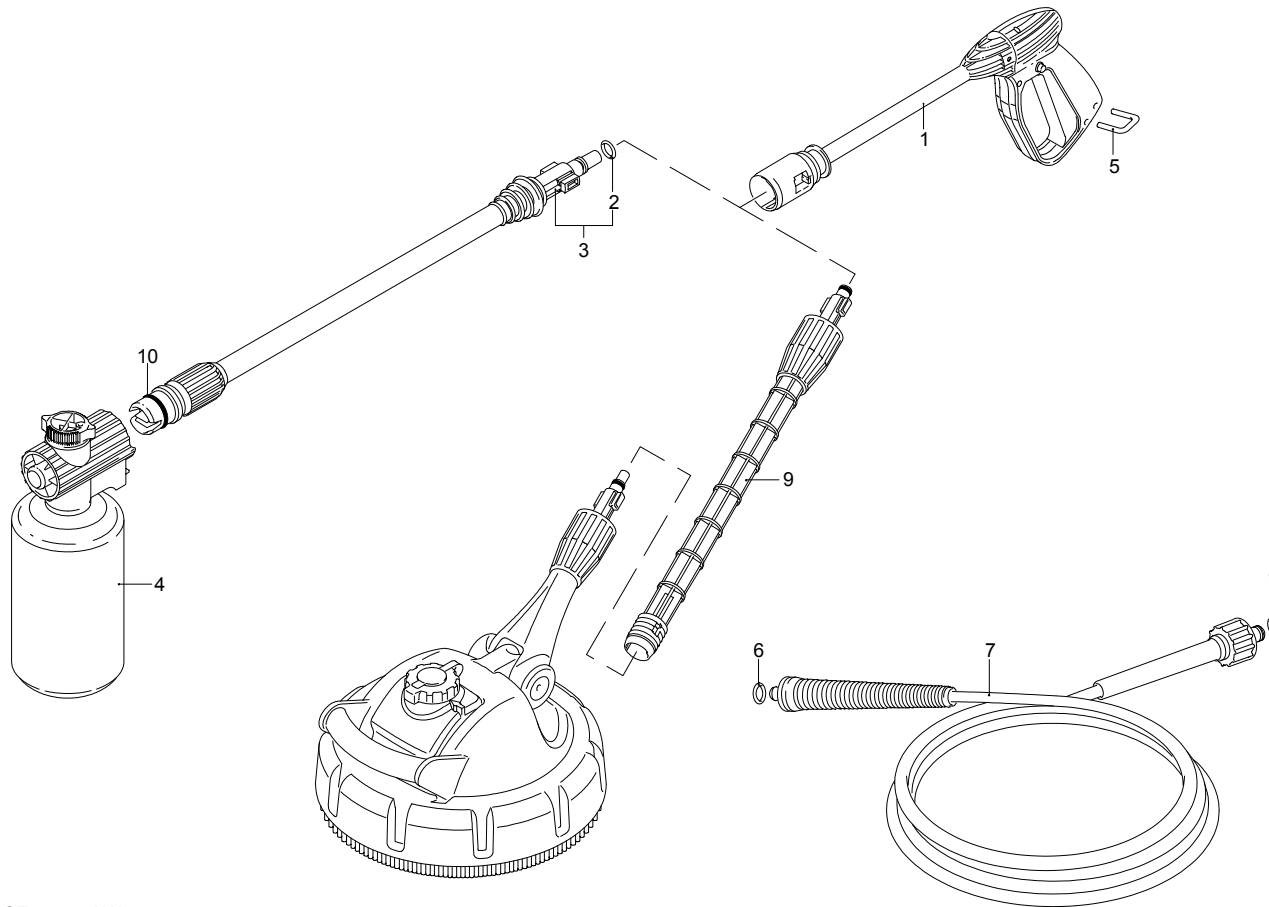
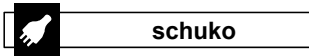
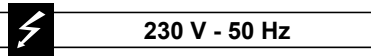

Gültigkeit	Pos.	Code	Bezeichnung	Menge
	1	40409	Pistole	1
	2	1680220	O-Ring-Dichtung	1
	3	40411	Lanze+Düsenkopf	1
	4	3641	Tank	1
	5	2000080	Klemme	1
	6	1080250	O-Ring-Dichtung	1
	7	2000420	Hochdruckschlauch	1
	8	2000770	O-Ring-Dichtung	1
	9	40499	Spinner	1
	10	2000520	O-Ring-Dichtung	1

UN_CE_0356-AW