



# Modell PW 1300 C

Ausführung: **PW 1300 C (08)**  
Seriennummer:   
Code: **12611**

01/02/2010

**230 V - 50 Hz** **schuko**

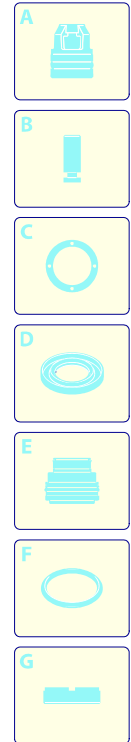
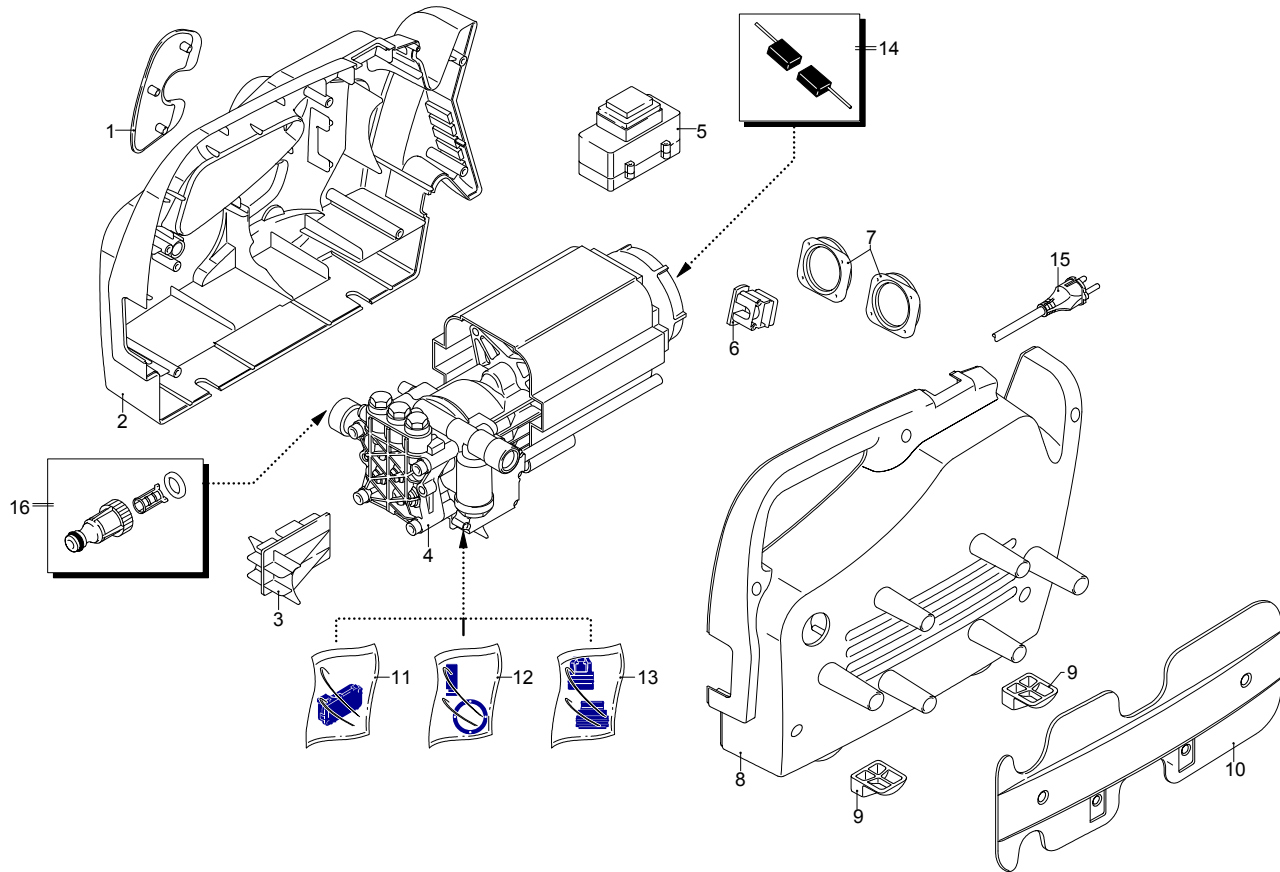

Gültigkeit	Pos.	Code	Bezeichnung	Menge
	1	3080590	Haken	1
	2	3080010	Orangefarbene Haube	1
	3	3080550	Halterung	1
	4	3081090	Vormontage Elektropumpe	1
	5	3080050	Schalter	1
	6	3080580	Kabelverschraubung	1
	7	3080560	Führung	2
	8	3080020	Orangefarbene Haube	1
	9	3080570	Haken	2
	10	3080040	Schutzeinrichtung	1
	11	3081280	Satz TSS	1
	12	3081270	Kolben + Dichtungssatz	1
	13	3081290	Ventile + Dichtungssatz	1
	14	3082580	Bürstesatz für Motor	1
	15	50940	Kabel	1
	16	3082130	Wasser Schnellverbindungsatz	1

UN\_CE\_0188-AW



# Modell PW 1300 C

Ausführung: **PW 1300 C (08)**

Seriennummer: \_\_\_\_\_

Code: **12611**

01/02/2010

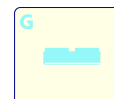
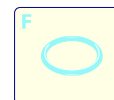
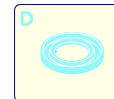
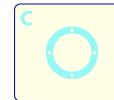
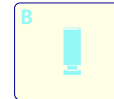
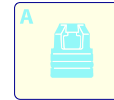
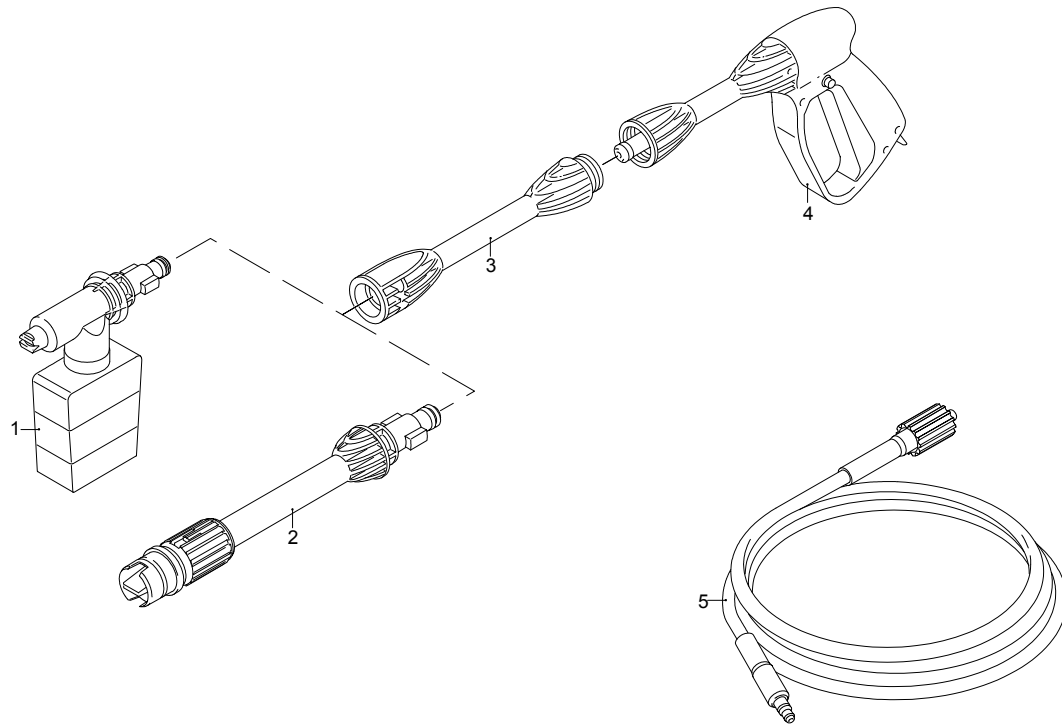
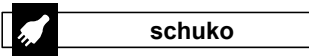
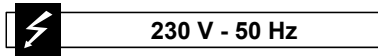

Gültigkeit	Pos.	Code	Bezeichnung	Menge
	1	3080030	Tank	1
	2	3080090	Lanze+Düsenkopf	1
	3	3080070	Verlängerung	1
	4	3080060	Pistole	1
	5	3081300	Hochdruckschlauch	1