



# Modell 737 RLW

Ausführung:

Seriennummer:

Code: **12389**

08/02/2010

230 V - 50 Hz

schuko

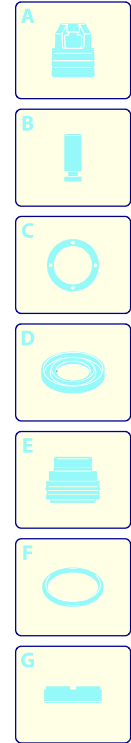
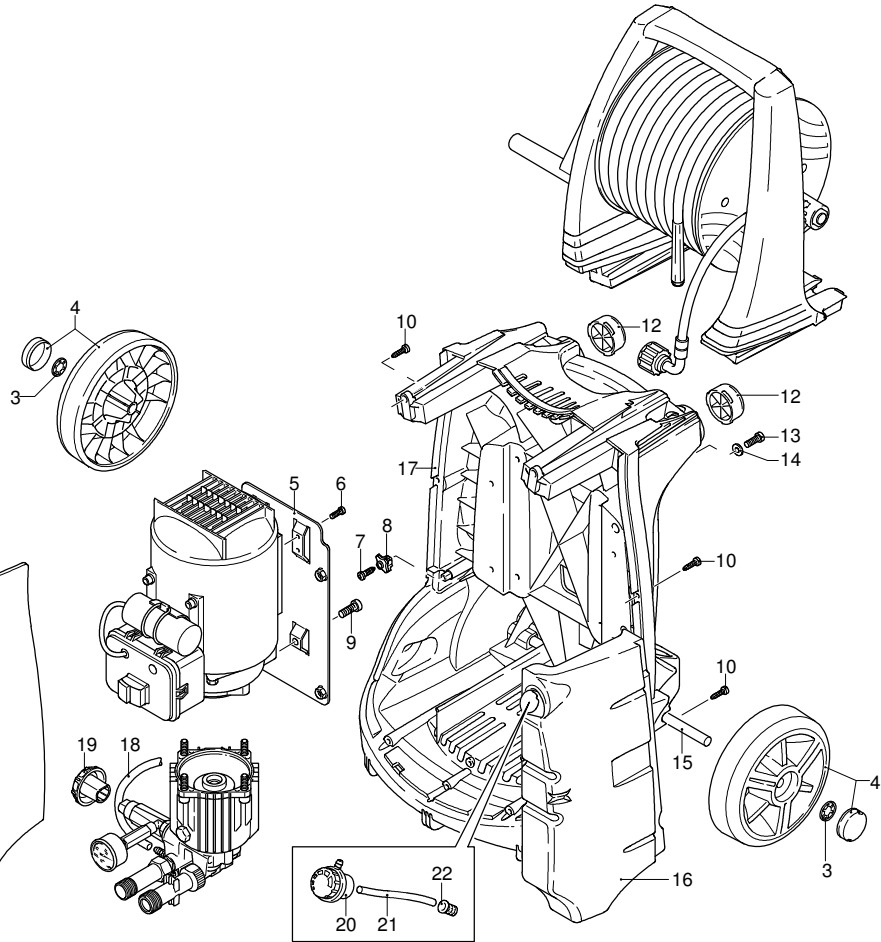
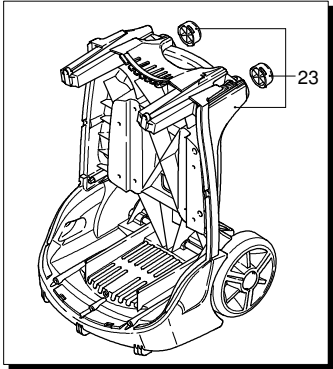

Gültigkeit	Pos.	Code	Bezeichnung	Menge
	1	2500050	Haken	1
	2	2500035	Dunkelblaue Haube	1
	3	1680880	Unterlegscheibe	2
	4	2500320	Rad	2
	5	2500090	Platte	1
	6	2320190	Schraube	2
	7	2100300	Schraube	1
	8	2600100	Kabelverschraubung	1
	9	850370	Schraube	2
	10	2100300	Schraube	7
	12	2500130	Gummifuß	2
	13	880280	Schraube	4
	14	2180300	Unterlegscheibe	4
	15	2500120	Achse	1
	16	2500110	Tank	1
	17	2500010	Basis	1
	18	1270960	Reinigungsmittelschlauch	1
	19	2500310	Knauf	1
	20	42113	Vormontage Verschluss	1
	21	2500330	Reinigungsmittelschlauch	1
	22	2000230	Filter	1
	23	2509000	Basis Vormontage	1

UN\_CE\_0079-HW



# Modell 737 RLW

Ausführung:

Seriennummer:

Code: **12389**

08/02/2010

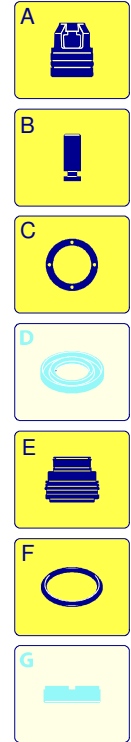
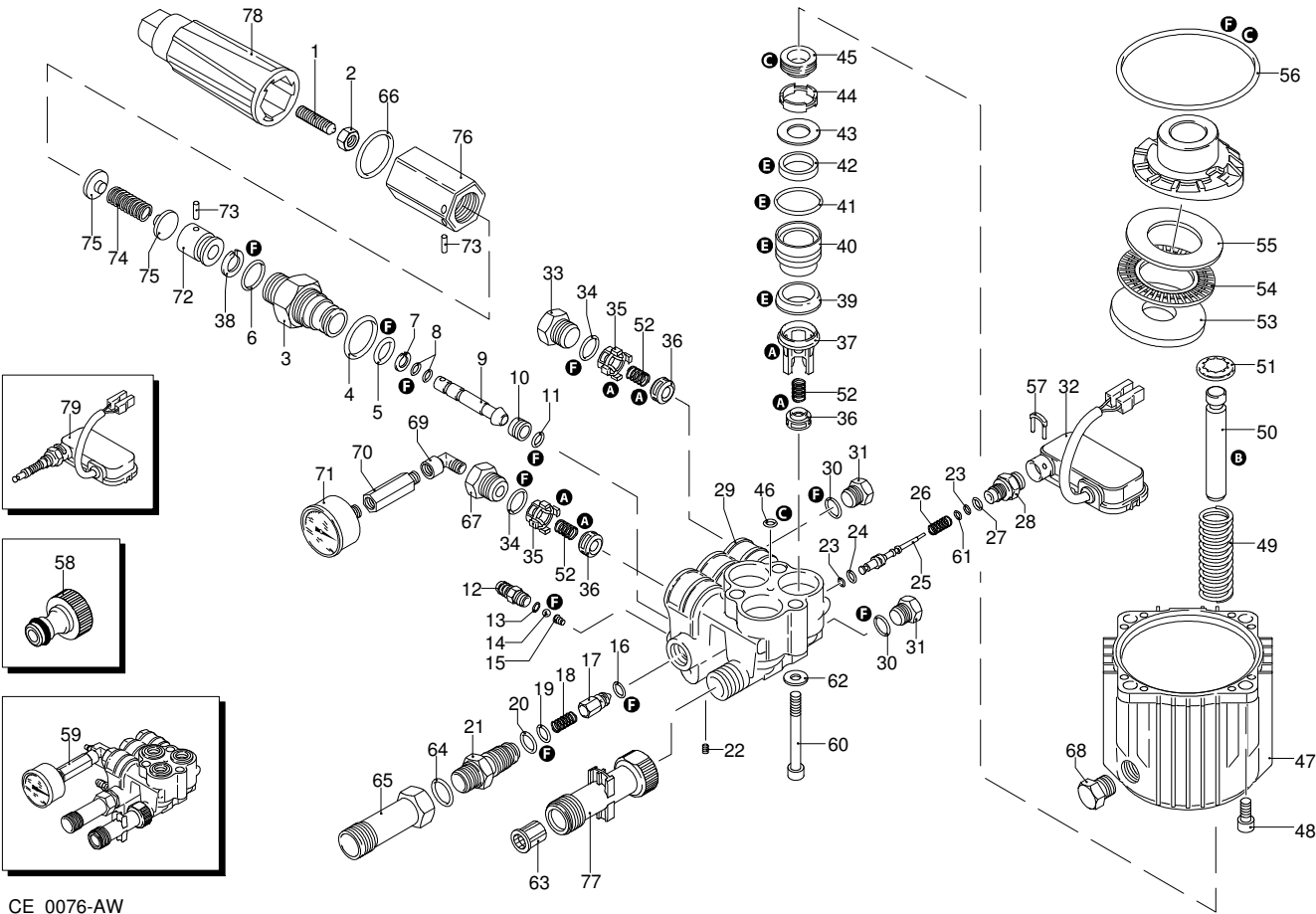
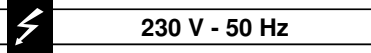

Gültigkeit	Pos.	Code	Bezeichnung	Menge
	1	1980470	Schraube	1
	2	1980300	Mutter	1
	3	1980210	Kolbenführung	1
	4	740290	O-Ring-Dichtung	1
	5	800560	O-Ring-Dichtung	1
	6	1080250	O-Ring-Dichtung	1
	7	1271170	Ring	1
	8	1080190	O-Ring-Dichtung	2
	9	1271160	Kolben	1
	10	1980200	Sitz	1
	11	1470210	O-Ring-Dichtung	1
	12	1982520	Schlauchanschluss	1
	13	480480	O-Ring-Dichtung	1
	14	1250280	Kugel	1
	15	1560520	Feder	1
	16	1460430	O-Ring-Dichtung	1
	17	1540170	Verschluss	1
	18	1080091	Feder	1
	19	394280	O-Ring-Dichtung	1
	20	1200690	O-Ring-Dichtung	1
	21	1270091	Injektor	1
	22	1981190	Schraube	1
	23	1080190	O-Ring-Dichtung	2
	24	660190	O-Ring-Dichtung	1
	25	1982990	Stange	1
	26	1981320	Feder	1
	27	880840	O-Ring-Dichtung	1
	28	1983360	Verbindungsstück	1
	29	1982170	Kopf	1
	30	820510	O-Ring-Dichtung	2
	31	880581	Verschluss	2
	32	2029752	Vormontage Kasten TSS	1
	33	1260162	Verschluss	2
	34	960160	O-Ring-Dichtung	3
	35	1981460	Buchse	3
	36	880240	Ventil	6
	37	1981450	Buchse	3
	38	1080401	Ring	1
	39	2460180	Wasserdichtung	3
	40	1981470	Kolbenführung	3
	41	770130	O-Ring-Dichtung	3
	42	1260440	Wasserdichtung	3
	43	1980170	Ring	3
	44	1980430	Distanzstück	3
	45	1260460	Öldichtung	3
	46	770090	O-Ring-Dichtung	1
	47	1980460	Pumpenkörper	1
	48	180030	Schraube	4
	49	1981140	Feder	3
	50	1981440	Kolben	3
	51	1980150	Ring	3
	52	1322230	Feder	6
	53	1980130	Zapfenlager	1
	54	1980250	Zapfenlager	1
	55	1980240	Zapfenlager	1
	56	1980340	O-Ring-Dichtung	1
	57	2022200	Klemme	1
	58	1461470	Verbindungsstück	1
	59	1989265	Vormontage Kopf	1
	60	1980310	Schraube	3
	61	1260820	O-Ring-Dichtung	1
	62	650530	Unterlegscheibe	3

UN\_CE\_0076-AW



# Modell 737 RLW

Ausführung:

Seriennummer:

Code: **12389**

08/02/2010

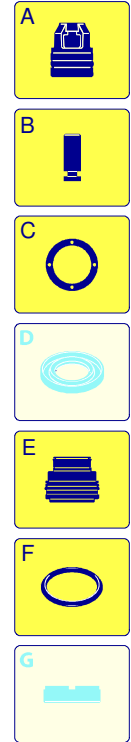
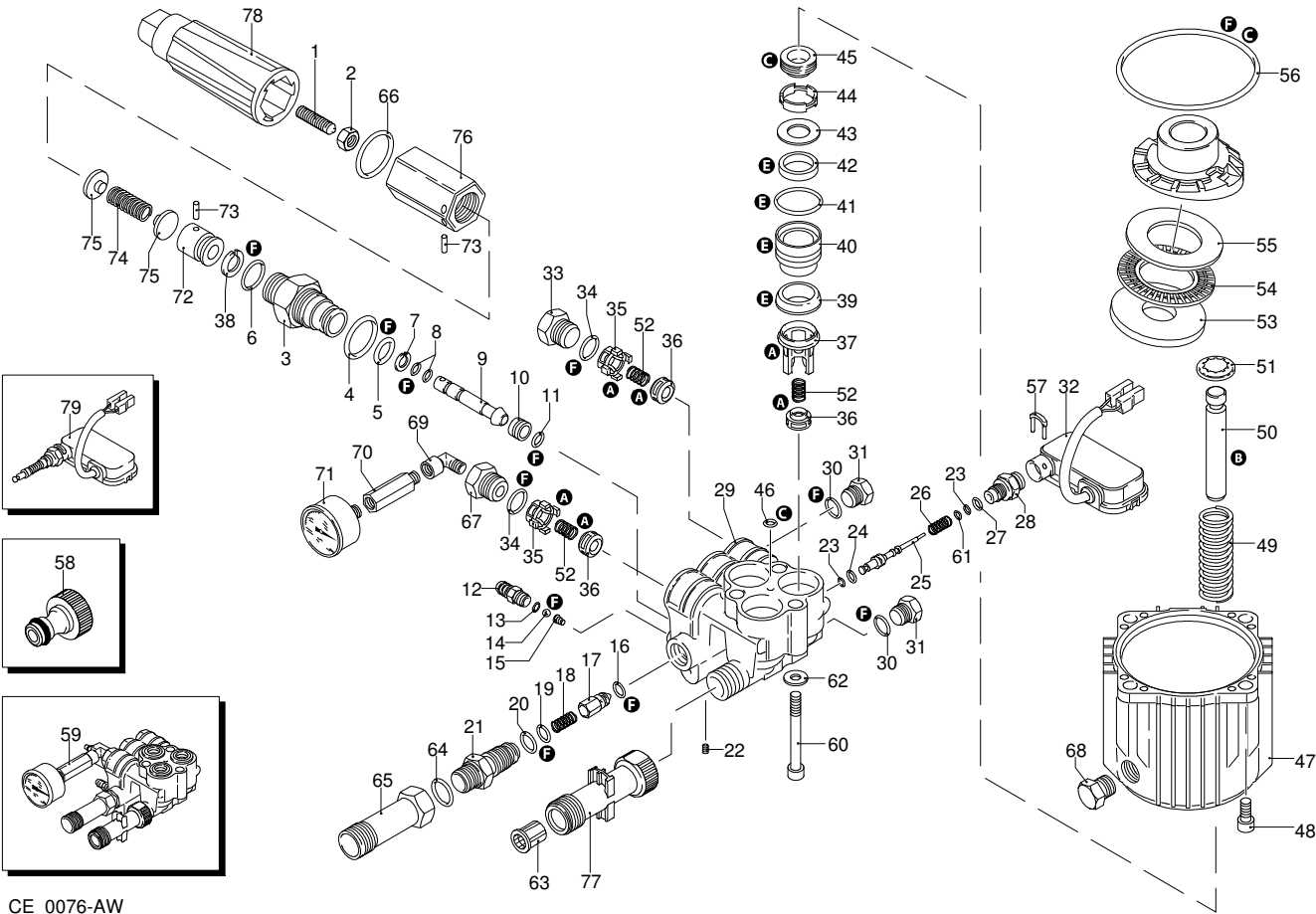
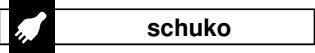
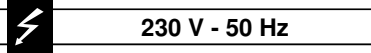

Gültigkeit	Pos.	Code	Bezeichnung	Menge
	63	1340260	Filter	1
	64	390180	O-Ring-Dichtung	1
	65	2440210	Verlängerung	1
	66	1150640	O-Ring-Dichtung	1
	67	2500450	Verschluss	1
	68	1980290	Verschluss	1
	69	1465850	Verbindungsstück	1
	70	2500140	Verlängerung	1
	71	3233	Manometer	1
	72	1080041	Kolben	1
	73	1080070	Stecker	1
	74	1271070	Feder	1
	75	1980220	Teller	2
	76	1980390	Einsatz	1
	77	2500270	Verlängerung	1
	78	2500080	Drehknopf	1
	79	42143	Satz TSS	1
	A	2581	Satz Ventile	1
	B	2593	Satz Kolben	1
	C	2511	Satz Öldichtungen	1
	E	2582	Satz Wasserdichtungen	1
	F	2799	Satz Dichtungen	1



# Modell 737 RLW

Ausführung:

Seriennummer:

Code: **12389**

08/02/2010

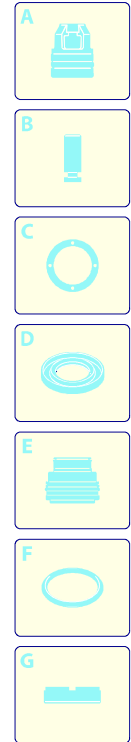
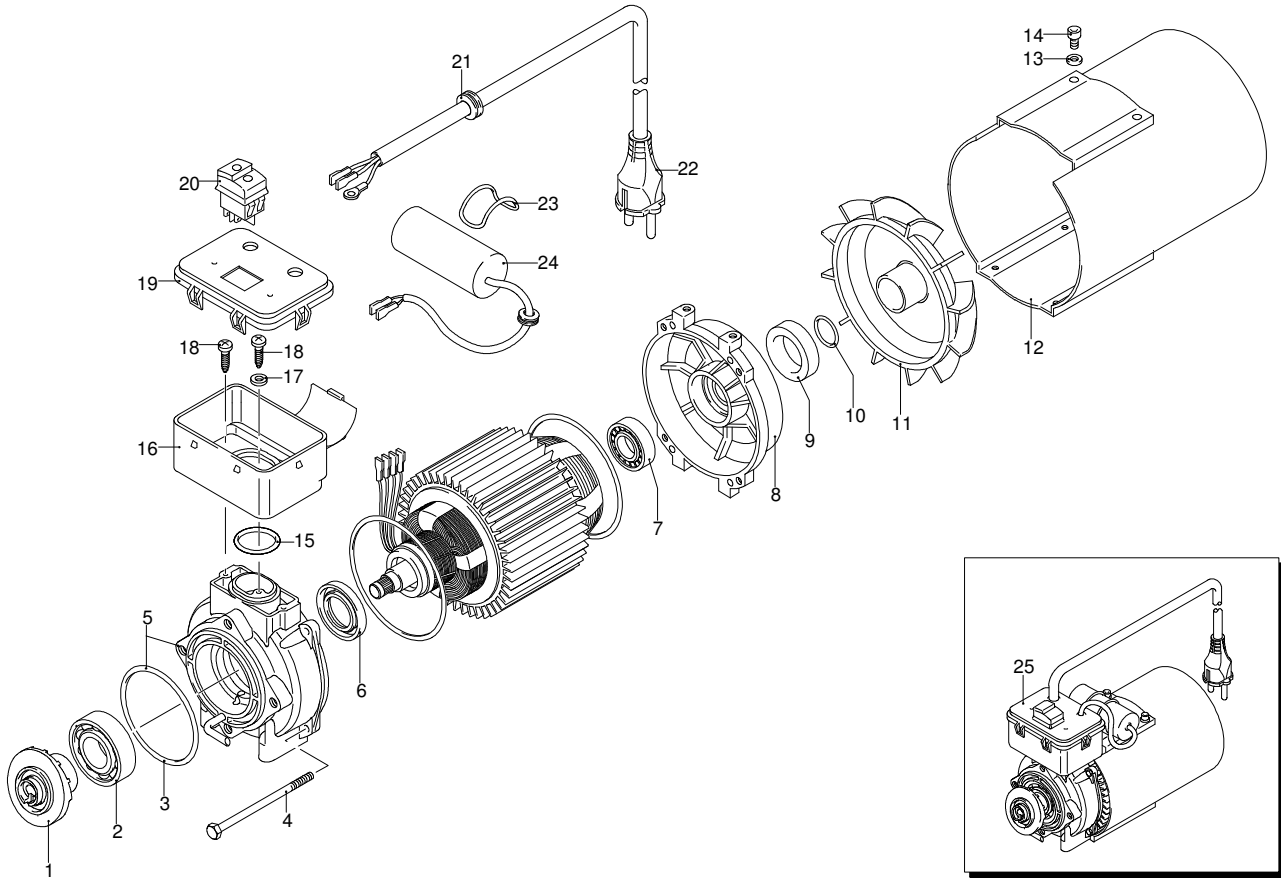
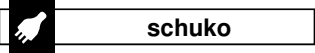
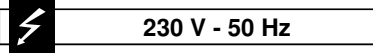

Gültigkeit	Pos.	Code	Bezeichnung	Menge
	1	1983110	Teller	1
	2	1981210	Lager	1
	3	1980340	O-Ring-Dichtung	1
	4	2320090	Schraube	4
	5	1982040	Flansch	1
	6	1260750	Öldichtung	1
	7	1460590	Lager	1
	8	1460040	Schutzschild	1
	9	1461200	Öldichtung	1
	10	394280	O-Ring-Dichtung	1
	11	1460370	Lüfter	1
	12	1460340	Leitblech	1
	13	1680960	Unterlegscheibe	2
	14	1460460	Schraube	2
	15	660170	O-Ring-Dichtung	1
	16	2320131	Kasten	1
	17	1262400	Unterlegscheibe	1
	18	2020570	Schraube	3
	19	2320270	Deckel	1
	20	2320280	Schalter	1
	21	2021480	Kabeldurchführung	1
	22	1760450	Kabel	1
	23	2100840	O-Ring-Dichtung	1
	24	1982590	Kondensator	1
	25	4601	Motor	1

UN\_CE\_0077-BX



# Modell 737 RLW

Ausführung:

Seriennummer:

Code: **12389**

08/02/2010

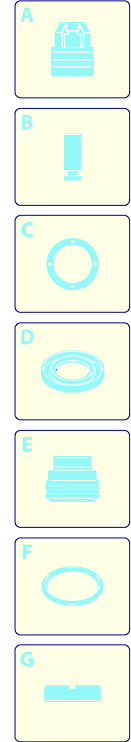
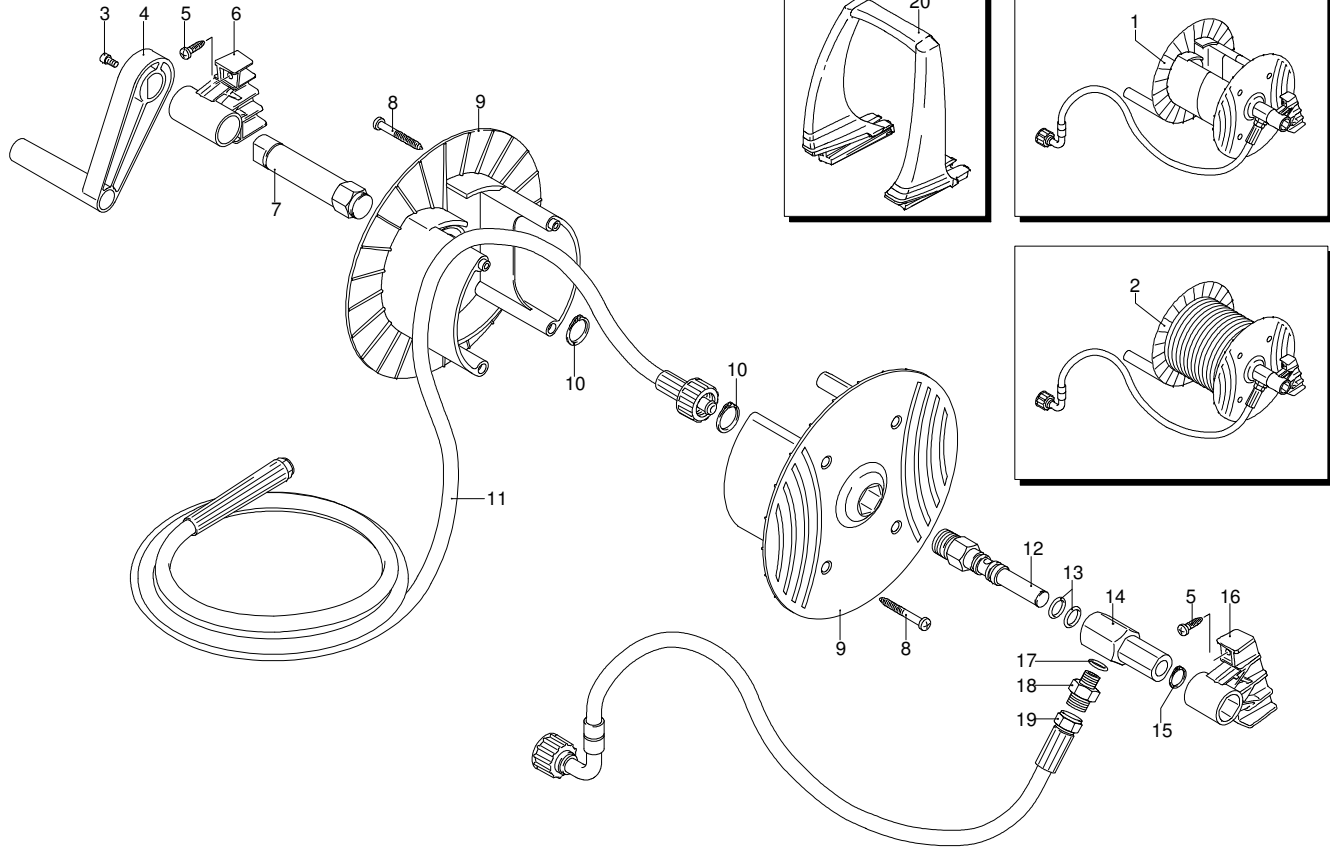
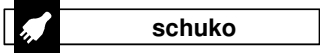
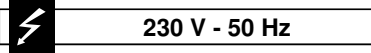

Gültigkeit	Pos.	Code	Bezeichnung	Menge
	1	40644	Vormontage Schlauchhaspel	1
	2	40377	Vormontage Schlauchhaspel	1
	3	2360360	Schraube	1
	4	2360150	Hebel	1
	5	2100300	Schraube	4
	6	2500060	Bügel	1
	7	2500360	Zapfen	1
	8	1681280	Schraube	4
	9	2360230	Scheibe	2
	10	380420	Ring	2
	11	2500460	Hochdruckschlauch	1
	12	2360210	Zapfen	1
	13	390080	O-Ring-Dichtung	2
	14	2360220	Verbindungsstück	1
	15	2360320	Ring	1
	16	2500070	Bügel	1
	17	820510	O-Ring-Dichtung	1
	18	2360310	Verbindungsstück	1
	19	2360250	Hochdruckschlauch	1
	20	2500020	Griff	1

UN\_CE\_0078-BX



# Modell 737 RLW

Ausführung:

Seriennummer:





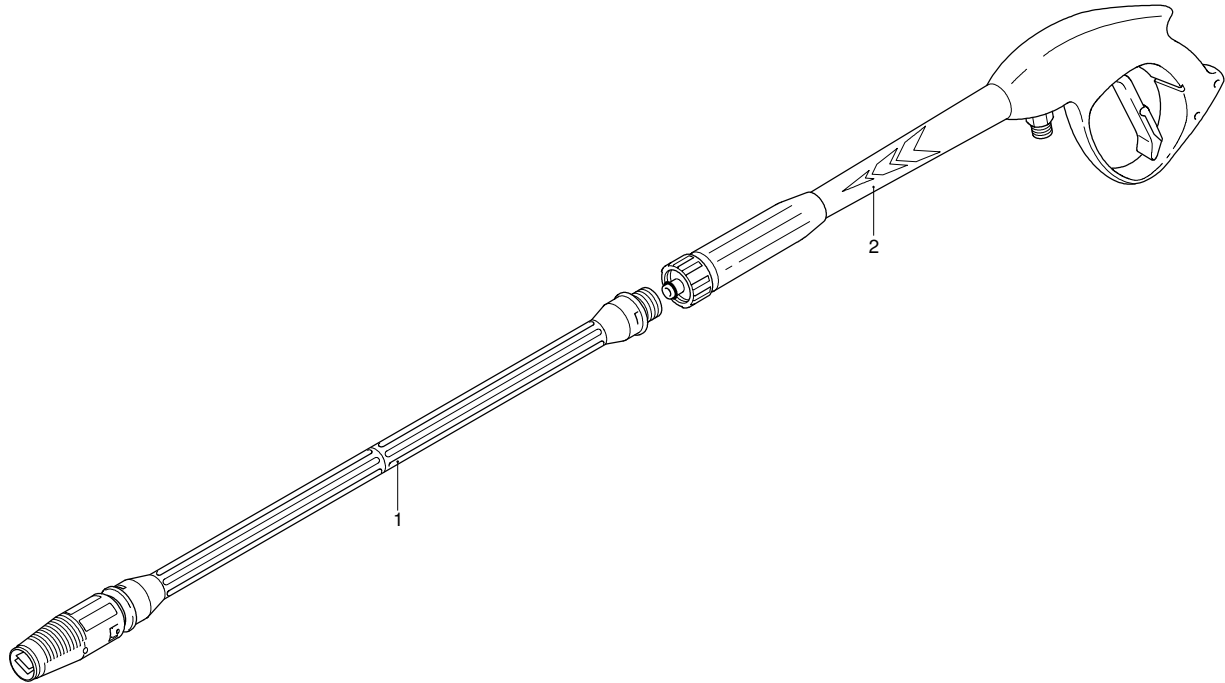

Code: **12389**

08/02/2010

 230 V - 50 Hz

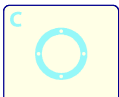
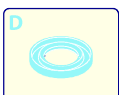
 schuko



- A 
- B 
- C 
- D 
- E 
- F 
- G 

Gültigkeit	Pos.	Code	Bezeichnung	Menge
	1	40206	Lanze+Düsenkopf	1
	2	40925	Pistole	1

UN\_CE\_0090-HW